

TLE202x, TLE202xA, TLE202xB, TLE202xY EXCALIBUR HIGH-SPEED LOW-POWER PRECISION OPERATIONAL AMPLIFIERS

SLOS191C – FEBRUARY 1997 – REVISED APRIL 2007

- Supply Current . . . 300 μ A Max
- High Unity-Gain Bandwidth . . . 2 MHz Typ
- High Slew Rate . . . 0.45 V/ μ s Min
- Supply-Current Change Over Military Temp Range . . . 10 μ A Typ at $V_{CC} \pm = \pm 15$ V
- Specified for Both 5-V Single-Supply and ± 15 -V Operation
- Phase-Reversal Protection
- High Open-Loop Gain . . . 6.5 V/ μ V (136 dB) Typ
- Low Offset Voltage . . . 100 μ V Max
- Offset Voltage Drift With Time 0.005 μ V/mo Typ
- Low Input Bias Current . . . 50 nA Max
- Low Noise Voltage . . . 19 nV/ $\sqrt{\text{Hz}}$ Typ

description

The TLE202x, TLE202xA, and TLE202xB devices are precision, high-speed, low-power operational amplifiers using a new Texas Instruments Excalibur process. These devices combine the best features of the OP21 with highly improved slew rate and unity-gain bandwidth.

The complementary bipolar Excalibur process utilizes isolated vertical pnp transistors that yield dramatic improvement in unity-gain bandwidth and slew rate over similar devices.

The addition of a bias circuit in conjunction with this process results in extremely stable parameters with both time and temperature. This means that a precision device remains a precision device even with changes in temperature and over years of use.

This combination of excellent dc performance with a common-mode input voltage range that includes the negative rail makes these devices the ideal choice for low-level signal conditioning applications in either single-supply or split-supply configurations. In addition, these devices offer phase-reversal protection circuitry that eliminates an unexpected change in output states when one of the inputs goes below the negative supply rail.

A variety of available options includes small-outline and chip-carrier versions for high-density systems applications.

The C-suffix devices are characterized for operation from 0°C to 70°C. The I-suffix devices are characterized for operation from –40°C to 85°C. The M-suffix devices are characterized for operation over the full military temperature range of –55°C to 125°C.



Please be aware that an important notice concerning availability, standard warranty, and use in critical applications of Texas Instruments semiconductor products and disclaimers thereto appears at the end of this data sheet.

All trademarks are the property of their respective owners.

PRODUCTION DATA information is current as of publication date. Products conform to specifications per the terms of Texas Instruments standard warranty. Production processing does not necessarily include testing of all parameters.



POST OFFICE BOX 655303 • DALLAS, TEXAS 75265

Copyright © 1997–2007, Texas Instruments Incorporated

TLE202x, TLE202xA, TLE202xB, TLE202xY EXCALIBUR HIGH-SPEED LOW-POWER PRECISION OPERATIONAL AMPLIFIERS

SLOS191C – FEBRUARY 1997 – REVISED APRIL 2007

TLE2021 AVAILABLE OPTIONS

T _A	V _{IO} max AT 25°C	PACKAGED DEVICES						CHIP FORM§ (Y)
		SMALL OUTLINE† (D)	SSOP‡ (DB)	CHIP CARRIER (FK)	CERAMIC DIP (JG)	PLASTIC DIP (P)	TSSOP‡ (PW)	
0°C to 70°C	200 µV 500 µV	TLE2021ACD TLE2021CD	TLE2021CDBLE	—	—	TLE2021ACP TLE2021CP	— TLE2021CPWLE	— TLE2021Y
-40°C to 85°C	200 µV 500 µV	TLE2021AID TLE2021ID	—	—	—	TLE2021AIP TLE2021IP	—	—
-55°C to 125°C	100 µV 200 µV 500 µV	— TLE2021AMD TLE2021MD	—	TLE2021BMFK TLE2021AMFK TLE2021MFK	TLE2021BMJG TLE2021AMJG TLE2021MJG	— TLE2021AMP TLE2021MP	—	—

† The D packages are available taped and reeled. To order a taped and reeled part, add the suffix R (e.g., TLE2021CDR).

‡ The DB and PW packages are only available left-end taped and reeled.

§ Chip forms are tested at 25°C only.

TLE2022 AVAILABLE OPTIONS

T _A	V _{IO} max AT 25°C	PACKAGED DEVICES						CHIP FORM§ (Y)
		SMALL OUTLINE† (D)	SSOP‡ (DB)	CHIP CARRIER (FK)	CERAMIC DIP (JG)	PLASTIC DIP (P)	TSSOP‡ (PW)	
0°C to 70°C	150 µV 300 µV 500 µV	TLE2022BCD TLE2022ACD TLE2022CD	— — TLE2022CDBLE	—	—	— TLE2022ACP TLE2022CP	— — TLE2022CPWLE	— — TLE2022Y
-40°C to 85°C	150 µV 300 µV 500 µV	TLE2022BID TLE2022AID TLE2022ID	—	—	—	— TLE2022AIP TLE2022IP	—	—
-55°C to 125°C	150 µV 300 µV 500 µV	— TLE2022AMD TLE2022MD	—	— TLE2022AMFK TLE2022MFK	TLE2022BMJG TLE2022AMJG TLE2022MJG	— TLE2022AMP TLE2022MP	—	—

† The D packages are available taped and reeled. To order a taped and reeled part, add the suffix R (e.g., TLE2022CDR).

‡ The DB and PW packages are only available left-end taped and reeled.

§ Chip forms are tested at 25°C only.

TLE2024 AVAILABLE OPTIONS

T _A	V _{IO} max AT 25°C	PACKAGED DEVICES				CHIP FORM§ (Y)
		SMALL OUTLINE (DW)	CHIP CARRIER (FK)	CERAMIC DIP (J)	PLASTIC DIP (N)	
0°C to 70°C	500 µV 750 µV 1000 µV	TLE2024BCDW TLE2024ACDW TLE2024CDW	—	—	TLE2024BCN TLE2024ACN TLE2024CN	— — TLE2024Y
-40°C to 85°C	500 µV 750 µV 1000 µV	TLE2024BIDW TLE2024AIDW TLE2024IDW	—	—	TLE2024BIN TLE2024AIN TLE2024IN	—
-55°C to 125°C	500 µV 750 µV 1000 µV	TLE2024BMDW TLE2024AMDW TLE2024MDW	TLE2024BMFK TLE2024AMFK TLE2024MFK	TLE2024BMJ TLE2024AMJ TLE2024MJ	TLE2024BMN TLE2024AMN TLE2024MN	—

§ Chip forms are tested at 25°C only.



TLE202x, TLE202xA, TLE202xB, TLE202xY EXCALIBUR HIGH-SPEED LOW-POWER PRECISION OPERATIONAL AMPLIFIERS

SLOS191C – FEBRUARY 1997 – REVISED APRIL 2007

TLE2021
D, DB, JG, P, OR PW PACKAGE
(TOP VIEW)

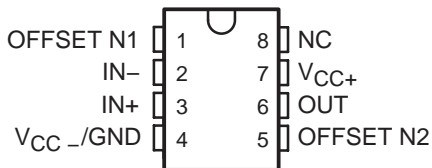

NC – No internal connection

TLE2021
FK PACKAGE
(TOP VIEW)

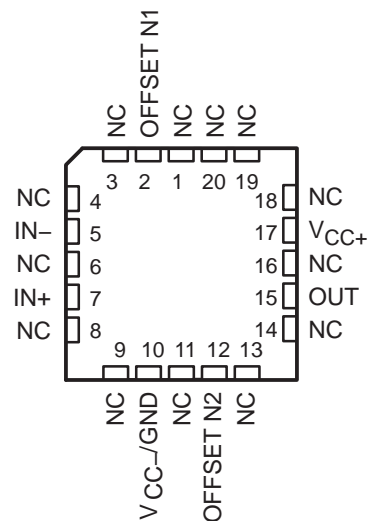

D, DB, JG, P, OR PW PACKAGE
(TOP VIEW)

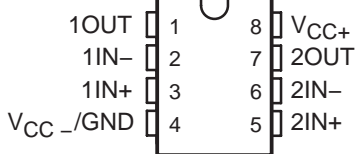

NC – No internal connection

FK PACKAGE
(TOP VIEW)

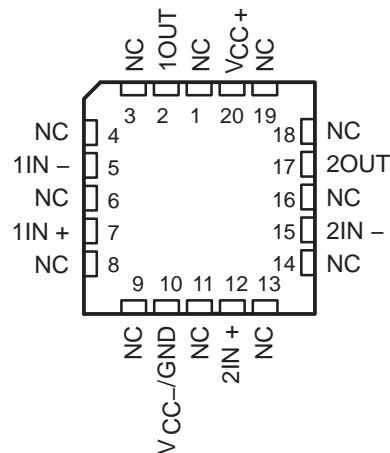

DW PACKAGE
(TOP VIEW)

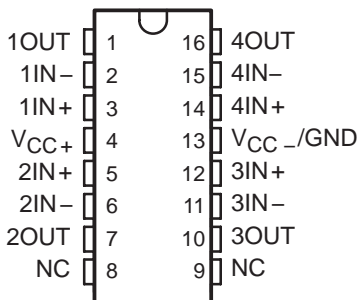

NC – No internal connection

FK PACKAGE
(TOP VIEW)

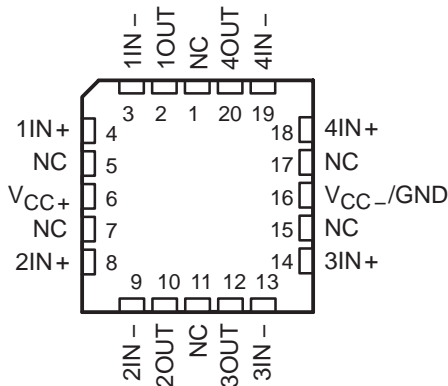

J OR N PACKAGE
(TOP VIEW)

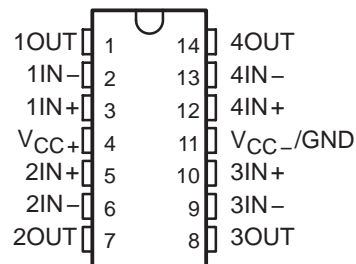

TLE202x, TLE202xA, TLE202xB, TLE202xY EXCALIBUR HIGH-SPEED LOW-POWER PRECISION OPERATIONAL AMPLIFIERS

SLOS191C – FEBRUARY 1997 – REVISED APRIL 2007

TLE2021Y chip information

This chip, when properly assembled, display characteristics similar to the TLE2021. Thermal compression or ultrasonic bonding may be used on the doped-aluminum bonding pads. This chip may be mounted with conductive epoxy or a gold-silicon preform.

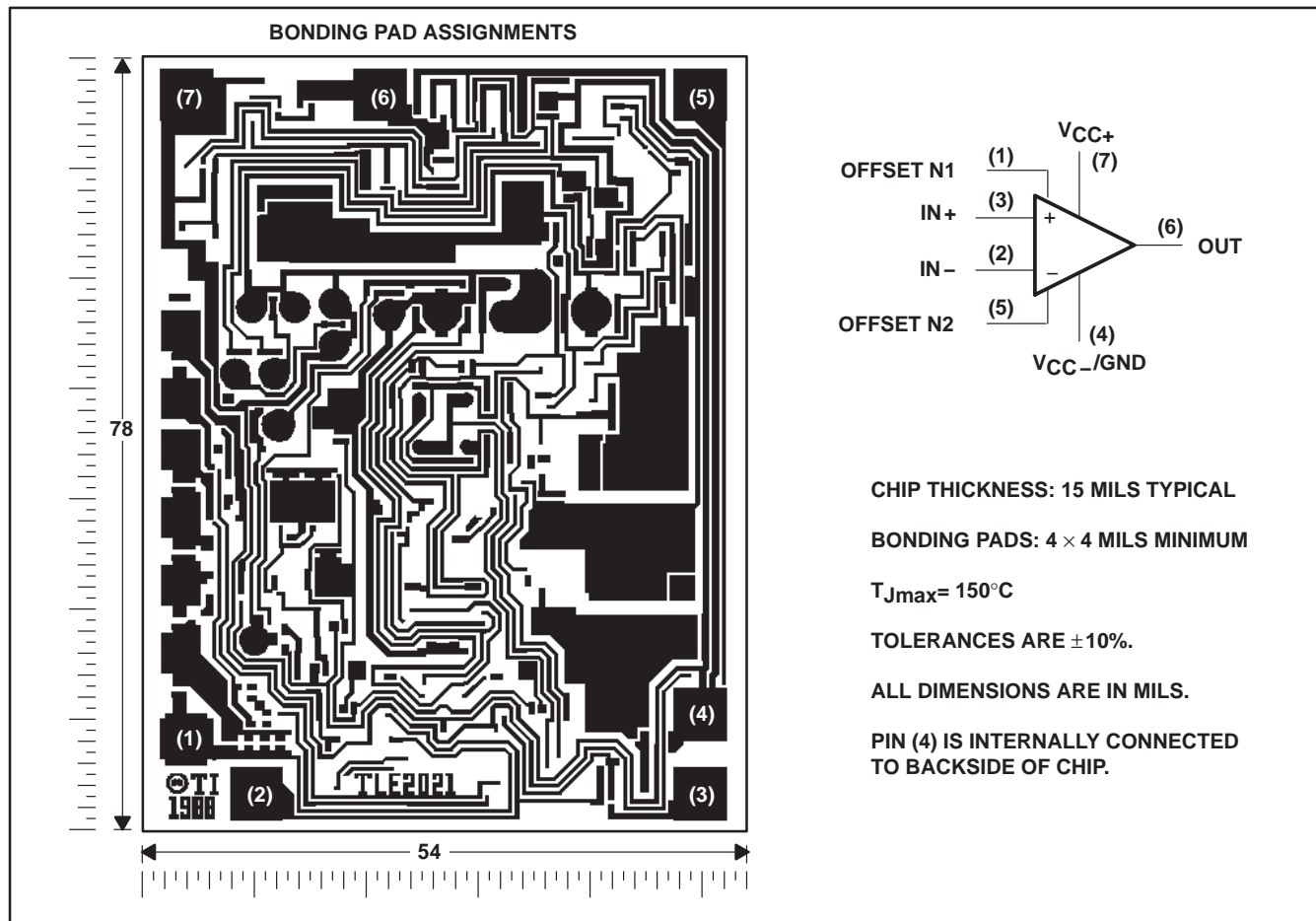

TLE202x, TLE202xA, TLE202xB, TLE202xY EXCALIBUR HIGH-SPEED LOW-POWER PRECISION OPERATIONAL AMPLIFIERS

SLOS191C – FEBRUARY 1997 – REVISED APRIL 2007

TLE2022Y chip information

This chip, when properly assembled, displays characteristics similar to TLE2022. Thermal compression or ultrasonic bonding may be used on the doped-aluminum bonding pads. This chip may be mounted with conductive epoxy or a gold-silicon preform.

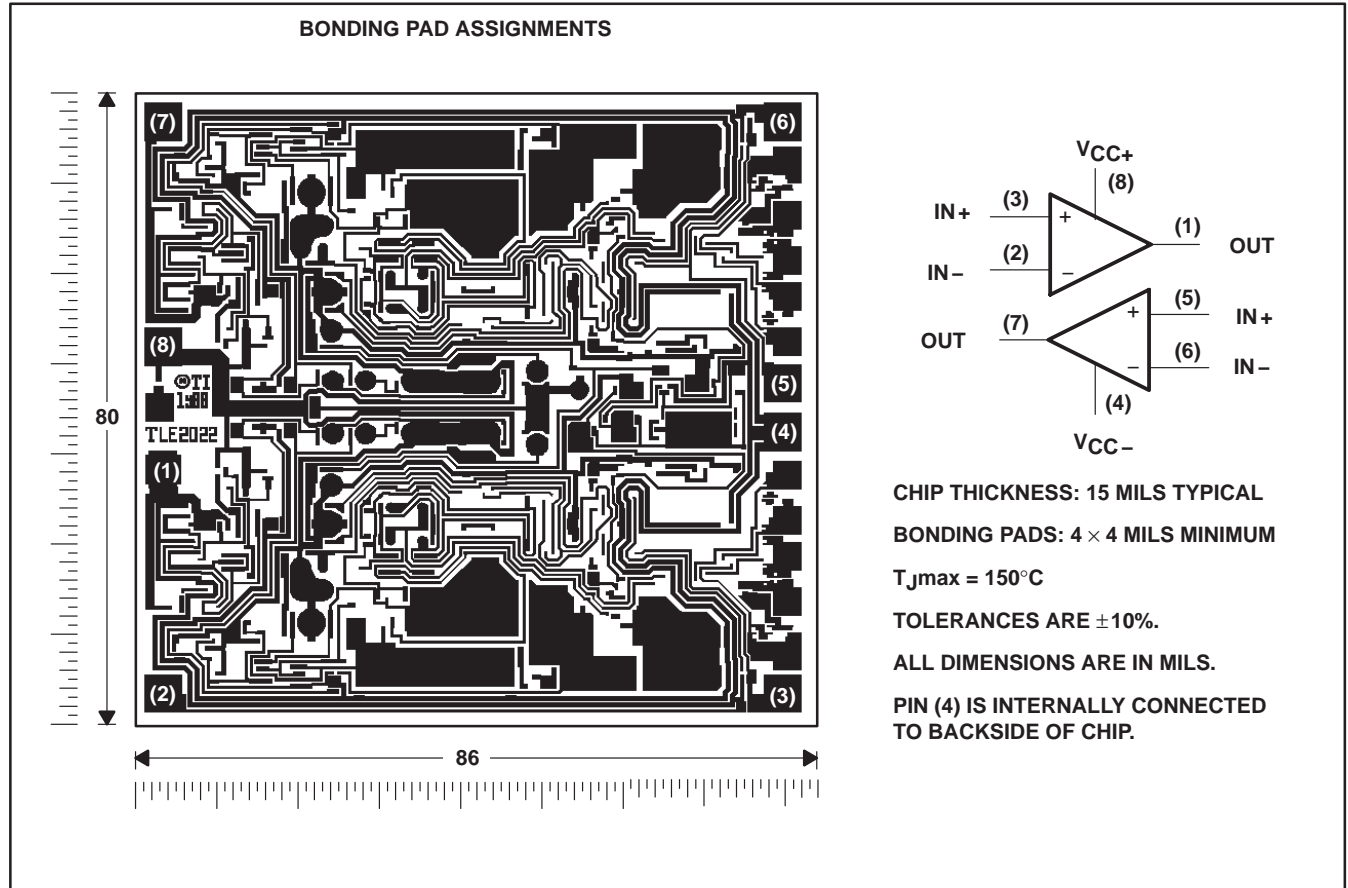

TLE202x, TLE202xA, TLE202xB, TLE202xY EXCALIBUR HIGH-SPEED LOW-POWER PRECISION OPERATIONAL AMPLIFIERS

SLOS191C – FEBRUARY 1997 – REVISED APRIL 2007

TLE2024Y chip information

This chip, when properly assembled, displays characteristics similar to the TLE2024. Thermal compression or ultrasonic bonding may be used on the doped aluminum-bonding pads. This chip may be mounted with conductive epoxy or a gold-silicon preform.

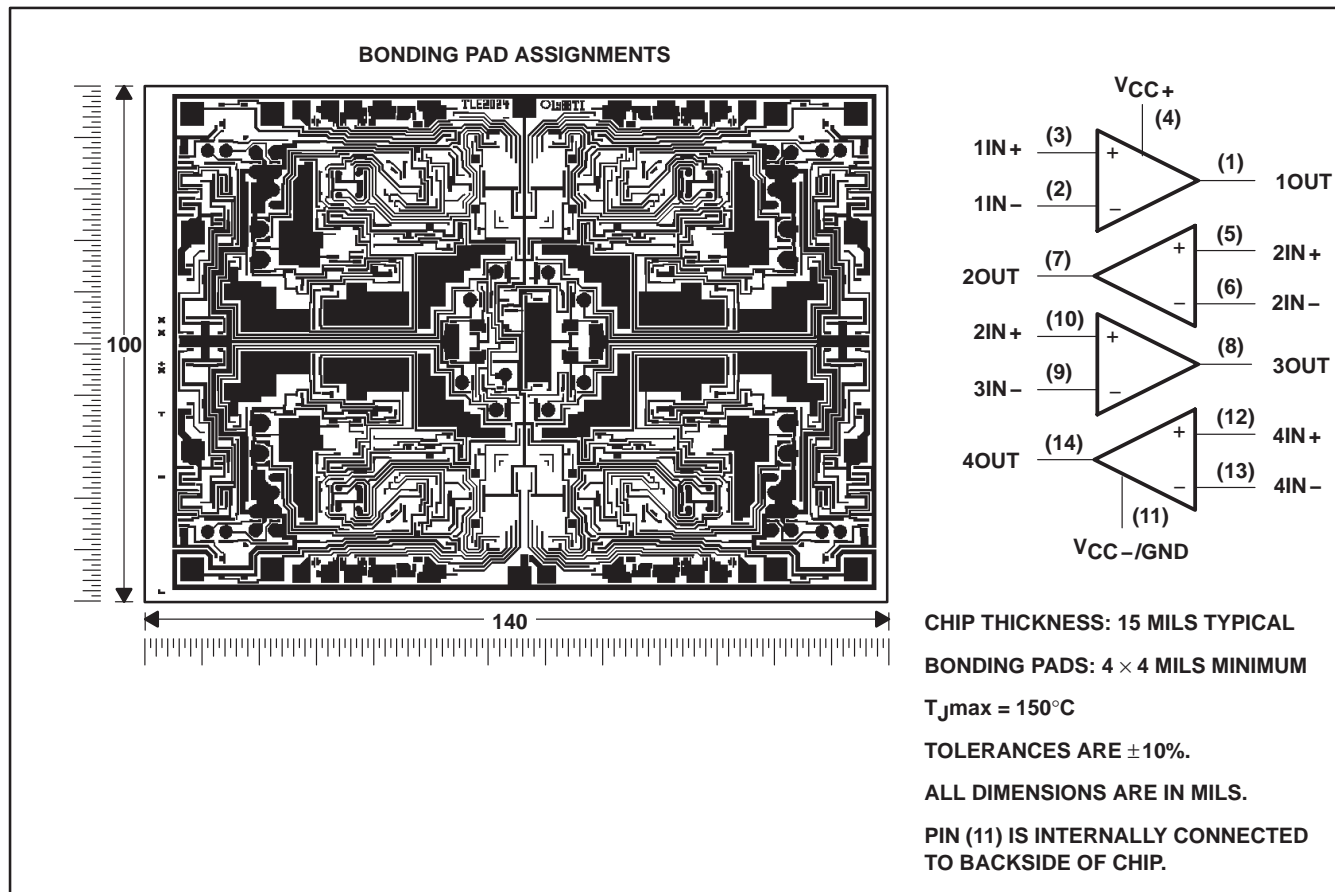

TLE202x, TLE202xA, TLE202xB, TLE202xY EXCALIBUR HIGH-SPEED LOW-POWER PRECISION OPERATIONAL AMPLIFIERS

SLOS191C – FEBRUARY 1997 – REVISED APRIL 2007

equivalent schematic (each amplifier)

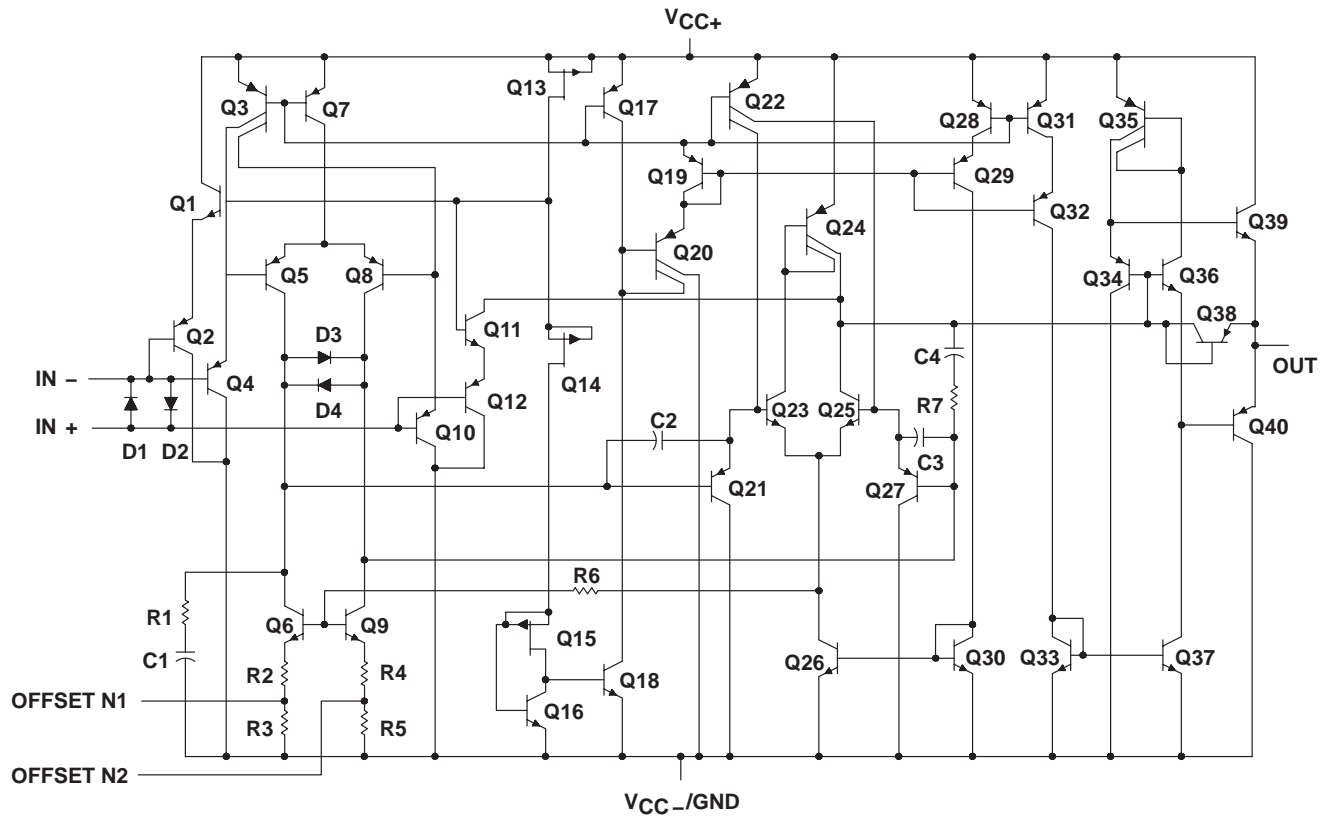

ACTUAL DEVICE COMPONENT COUNT			
COMPONENT	TLE2021	TLE2022	TLE2024
Transistors	40	80	160
Resistors	7	14	28
Diodes	4	8	16
Capacitors	4	8	16

TLE202x, TLE202xA, TLE202xB, TLE202xY EXCALIBUR HIGH-SPEED LOW-POWER PRECISION OPERATIONAL AMPLIFIERS

SLOS191C – FEBRUARY 1997 – REVISED APRIL 2007

absolute maximum ratings over operating free-air temperature range (unless otherwise noted)†

Supply voltage, V_{CC+} (see Note 1)	20 V
Supply voltage, V_{CC-} (see Note 1)	-20 V
Differential input voltage, V_{ID} (see Note 2)	± 0.6 V
Input voltage range, V_I (any input, see Note 1)	$\pm V_{CC}$
Input current, I_I (each input)	± 1 mA
Output current, I_O (each output):	
TLE2021	± 20 mA
TLE2022	± 30 mA
TLE2024	± 40 mA
Total current into V_{CC+}	80 mA
Total current out of V_{CC-}	80 mA
Duration of short-circuit current at (or below) 25°C (see Note 3)	unlimited
Continuous total power dissipation	See Dissipation Rating Table
Operating free-air temperature range, T_A : C suffix	0°C to 70°C
I suffix	-40°C to 85°C
M suffix	-55°C to 125°C
Storage temperature range, T_{stg}	-65°C to 150°C
Case temperature for 60 seconds, T_C : FK package	260°C
Lead temperature 1,6 mm (1/16 inch) from case for 10 seconds: D, DP, P, or PW package	260°C
Lead temperature 1,6 mm (1/16 inch) from case for 60 seconds: JG package	300°C

† Stresses beyond those listed under “absolute maximum ratings” may cause permanent damage to the device. These are stress ratings only, and functional operation of the device at these or any other conditions beyond those indicated under “recommended operating conditions” is not implied. Exposure to absolute-maximum-rated conditions for extended periods may affect device reliability.

- NOTES:
- All voltage values, except differential voltages, are with respect to the midpoint between V_{CC+} , and V_{CC-} .
 - Differential voltages are at $IN+$ with respect to $IN-$. Excessive current flows if a differential input voltage in excess of approximately ± 600 mV is applied between the inputs unless some limiting resistance is used.
 - The output may be shorted to either supply. Temperature and/or supply voltages must be limited to ensure that the maximum dissipation rating is not exceeded.

DISSIPATION RATING TABLE

PACKAGE	$T_A \leq 25^\circ\text{C}$ POWER RATING	DERATING FACTOR ABOVE $T_A = 25^\circ\text{C}$	$T_A = 70^\circ\text{C}$ POWER RATING	$T_A = 85^\circ\text{C}$ POWER RATING	$T_A = 125^\circ\text{C}$ POWER RATING
D-8	725 mW	5.8 mW/°C	464 mW	377 mW	145 mW
DB-8	525 mW	4.2 mW/°C	336 mW	—	—
DW-16	1025 mW	8.2 mW/°C	656 mW	533 mW	205 mW
FK	1375 mW	11.0 mW/°C	880 mW	715 mW	275 mW
J-14	1375 mW	11.0 mW/°C	880 mW	715 mW	275 mW
JG-8	1050 mW	8.4 mW/°C	672 mW	546 mW	210 mW
N-14	1150 mW	9.2 mW/°C	736 mW	598 mW	230 mW
P-8	1000 mW	8.0 mW/°C	640 mW	520 mW	200 mW
PW-8	525 mW	4.2 mW/°C	336 mW	—	—

recommended operating conditions

	C SUFFIX		I SUFFIX		M SUFFIX		UNIT
	MIN	MAX	MIN	MAX	MIN	MAX	
Supply voltage, V_{CC}	± 2	± 20	± 2	± 20	± 2	± 20	V
Common-mode input voltage, V_{IC}	$V_{CC} = \pm 5$ V		0	3.5	0	3.2	V
	$V_{CC\pm} = \pm 15$ V		-15	13.5	-15	13.2	
Operating free-air temperature, T_A	0	70	-40	85	-55	125	°C



TLE202x, TLE202xA, TLE202xB, TLE202xY EXCALIBUR HIGH-SPEED LOW-POWER PRECISION OPERATIONAL AMPLIFIERS

SLOS191C – FEBRUARY 1997 – REVISED APRIL 2007

TLE2021 electrical characteristics at specified free-air temperature, $V_{CC} = 5\text{ V}$ (unless otherwise noted)

PARAMETER	TEST CONDITIONS	T_A †	TLE2021C			TLE2021AC			TLE2021BC			UNIT
			MIN	TYP	MAX	MIN	TYP	MAX	MIN	TYP	MAX	
V_{IO} Input offset voltage	$V_{IC} = 0, R_S = 50\ \Omega$	25°C	120	600	300	100	300	200	80	200	μV	
α_{VIO} Temperature coefficient of input offset voltage		Full range		850	600			300				
Input offset voltage long-term drift (see Note 4)		Full range		2			2			2	$\mu\text{V}/^\circ\text{C}$	
I_{IO} Input offset current	$V_{IC} = 0, R_S = 50\ \Omega$	25°C	0.005			0.005			0.005		$\mu\text{V}/\text{mo}$	
I_{IB} Input bias current		25°C	0.2	6	6	0.2	6	6	0.2	6	nA	
		Full range		10	10		10	10		10		
V_{ICR} Common-mode input voltage range	$R_S = 50\ \Omega$	25°C	0	-0.3 to 3.5	0 to 4	-0.3 to 3.5	0 to 4	0 to 3.5	-0.3 to 4		V	
		Full range		0 to 3.5	0 to 3.5		0 to 3.5		0 to 3.5			
V_{OH} High-level output voltage	$R_L = 10\ \text{k}\Omega$	25°C	4	4.3		4	4.3		4	4.3	V	
V_{OL} Low-level output voltage		Full range		3.9			3.9			3.9		
		Large-signal differential voltage amplification	25°C	0.7	0.8	0.8	0.7	0.8	0.8	0.7	0.8	V
A_{VD} Large-signal differential voltage amplification	$V_O = 1.4\text{ V to }4\text{ V}, R_L = 10\ \text{k}\Omega$	Full range		0.85			0.85			0.85		
$CMRR$ Common-mode rejection ratio	$V_{IC} = V_{ICR\text{ min}}, R_S = 50\ \Omega$	25°C	85	110		85	110		85	110	dB	
k_{SVR} Supply-voltage rejection ratio ($\Delta V_{CC}/\Delta V_{IO}$)	$V_{CC} = 5\text{ V to }30\text{ V}$	Full range		80			80			80	dB	
I_{CC} Supply current	$V_O = 2.5\text{ V}, \text{ No load}$	25°C	105	120		105	120		105	120	dB	
		Full range		100			100			100		
ΔI_{CC} Supply-current change over operating temperature range	$V_O = 2.5\text{ V}, \text{ No load}$	25°C	200	300		200	300		200	300	μA	
		Full range		300			300			300		
ΔI_{CC} Supply-current change over operating temperature range	$V_O = 2.5\text{ V}, \text{ No load}$	25°C	5			5			5		μA	
		Full range										

† Full range is 0°C to 70°C.
 NOTE 4: Typical values are based on the input offset voltage shift observed through 168 hours of operating life test at $T_A = 150^\circ\text{C}$ extrapolated to $T_A = 25^\circ\text{C}$ using the Arrhenius equation and assuming an activation energy of 0.96 eV.



TLE202x, TLE202xA, TLE202xB, TLE202xY EXCALIBUR HIGH-SPEED LOW-POWER PRECISION OPERATIONAL AMPLIFIERS

SLOS191C – FEBRUARY 1997 – REVISED APRIL 2007

TLE2021 electrical characteristics at specified free-air temperature, $V_{CC} = \pm 15\text{ V}$ (unless otherwise noted)

PARAMETER	TEST CONDITIONS	T _A †	TLE2021C			TLE2021AC			TLE2021BC			UNIT
			MIN	TYP	MAX	MIN	TYP	MAX	MIN	TYP	MAX	
V _{IO} Input offset voltage		25°C	120	500	200	80	200	40	100	100	μV	
α _{VIO} Temperature coefficient of input offset voltage		Full range		750	500				200		μV/°C	
Input offset voltage long-term drift (see Note 4)	V _{IC} = 0, R _S = 50 Ω	Full range	2			2		2			μV/°C	
I _{IO} Input offset current		25°C	0.006			0.006		0.006			μV/mo	
I _{IB} Input bias current		25°C	0.2	6	6	0.2	6	0.2	6	6	nA	
		Full range		10	10		10		10		nA	
		25°C	25	70	70	25	70	25	70	70	nA	
		Full range		90	90		90		90		nA	
V _{ICR} Common-mode input voltage range	R _S = 50 Ω	25°C	-15 to 13.5	-15.3 to 14	-15 to 13.5	-15 to 13.5	-15.3 to 14	-15 to 13.5	-15.3 to 14	-15 to 13.5	V	
		Full range	-15 to 13.5	-15.3 to 14	-15 to 13.5	-15 to 13.5	-15.3 to 14	-15 to 13.5	-15.3 to 14	-15 to 13.5	V	
V _{OM+} Maximum positive peak output voltage swing		25°C	14	14.3	14	14	14.3	14	14.3	14	V	
		Full range	13.9		13.9	13.9		13.9		13.9	V	
V _{OM-} Maximum negative peak output voltage swing	R _L = 10 kΩ	25°C	-13.7	-14.1	-13.7	-13.7	-14.1	-13.7	-14.1	-13.7	V	
		Full range	-13.7		-13.7	-13.7		-13.7		-13.7	V	
A _{VD} Large-signal differential voltage amplification	V _O = ±10 V, R _L = 10 kΩ	25°C	1	6.5	1	1	6.5	1	6.5	1	V/μV	
		Full range	1		1	1		1		1	V/μV	
CMRR Common-mode rejection ratio	V _{IC} = V _{ICR} min, R _S = 50 Ω	25°C	100	115	100	100	115	100	115	100	dB	
		Full range	96		96	96		96		96	dB	
k _{SVR} Supply-voltage rejection ratio (ΔV _{CC} /ΔV _{IO})	V _{CC} ± ± 2.5 V to ± 15 V	25°C	105	120	105	105	120	105	120	105	dB	
		Full range	100		100	100		100		100	dB	
I _{CC} Supply current		25°C	240	350	240	240	350	240	350	240	μA	
		Full range	350		350	350		350		350	μA	
ΔI _{CC} Supply-current change over operating temperature range	V _O = 0, No load	Full range	6		6	6		6		6	μA	

† Full range is 0°C to 70°C.

NOTE 4: Typical values are based on the input offset voltage shift observed through 168 hours of operating life test at T_A = 150°C extrapolated to T_A = 25°C using the Arrhenius equation and assuming an activation energy of 0.96 eV.

TLE202x, TLE202xA, TLE202xB, TLE202xY EXCALIBUR HIGH-SPEED LOW-POWER PRECISION OPERATIONAL AMPLIFIERS

SLOS191C – FEBRUARY 1997 – REVISED APRIL 2007

TLE2022 electrical characteristics at specified free-air temperature, $V_{CC} = 5\text{ V}$ (unless otherwise noted)

PARAMETER	TEST CONDITIONS	T_A †	TLE2022C			TLE2022AC			TLE2022BC			UNIT
			MIN	TYP	MAX	MIN	TYP	MAX	MIN	TYP	MAX	
V_{IO}	$V_{IC} = 0$, $R_S = 50\ \Omega$	25°C			600			400			250	μV
α_{VIO}		Full range			800			550			400	
Input offset voltage long-term drift (see Note 4)		Full range	2								2	$\mu\text{V}/^\circ\text{C}$
I_{IO}	$V_{IC} = 0$, $R_S = 50\ \Omega$	25°C	0.005			0.005			0.005			$\mu\text{V}/\text{mo}$
Input offset current		25°C	0.5	6	6	0.4	6	6	0.3	6		nA
		Full range		10	10		10	10		10		
I_{IB}	25°C	35	70	70	33	70	70	30	70		nA	
	Full range		90	90		90	90		90			
V_{ICR}	$R_S = 50\ \Omega$	25°C	0	-0.3 to 3.5	0	-0.3 to 3.5	0	-0.3 to 3.5	0	-0.3 to 3.5	0	V
		Full range	0	to 3.5	0	to 3.5	0	to 3.5	0	to 3.5	0	
V_{OH}	$R_L = 10\ \text{k}\Omega$	25°C	4	4.3	4	4.3	4	4.3	4	4.3	4	V
		Full range	3.9		3.9		3.9		3.9		3.9	
V_{OL}	$R_L = 10\ \text{k}\Omega$	25°C	0.7	0.8	0.7	0.8	0.7	0.8	0.7	0.8	0.8	V
		Full range		0.85		0.85		0.85		0.85		
A_{VD}	$V_O = 1.4\text{ V to }4\text{ V}$, $R_L = 10\ \text{k}\Omega$	25°C	0.3	1.5	0.4	1.5	0.4	1.5	0.5	1.5	1.5	V/ μV
		Full range	0.3		0.4		0.4		0.5		0.5	
CMRR	$V_{IC} = V_{ICRmin}$, $R_S = 50\ \Omega$	25°C	85	100	87	102	87	102	90	105	105	dB
		Full range	80		82		82		85		85	
kSVR	$V_{CC} = 5\text{ V to }30\text{ V}$	25°C	100	115	103	118	103	118	105	120	120	dB
		Full range	95		98		98		100		100	
I_{CC}	$V_O = 2.5\text{ V}$, No load	25°C	450	600	450	600	450	600	450	600	600	μA
		Full range	600		600		600		600		600	
ΔI_{CC}	Supply current change over operating temperature range	25°C	7		7		7		7		7	μA
		Full range										

† Full range is 0°C to 70°C.
NOTE 4: Typical values are based on the input offset voltage shift observed through 168 hours of operating life test at $T_A = 150^\circ\text{C}$ extrapolated to $T_A = 25^\circ\text{C}$ using the Arrhenius equation and assuming an activation energy of 0.96 eV.



TLE202x, TLE202xA, TLE202xB, TLE202xY EXCALIBUR HIGH-SPEED LOW-POWER PRECISION OPERATIONAL AMPLIFIERS

SLOS191C – FEBRUARY 1997 – REVISED APRIL 2007

TLE2022 electrical characteristics at specified free-air temperature, $V_{CC} = \pm 15$ V (unless otherwise noted)

PARAMETER	TEST CONDITIONS	T _A †	TLE2022C			TLE2022AC			TLE2022BC			UNIT
			MIN	TYP	MAX	MIN	TYP	MAX	MIN	TYP	MAX	
V _{IO}	V _{IC} = 0, R _S = 50 Ω	25°C	150	120	300	150	120	300	70	150	μV	
α _{VIO}		Full range	700	450	300	700	450	300	300	300	μV/°C	
Input offset voltage long-term drift (see Note 4)		Full range	2	2	2	2	2	2	2	2	μV/°C	
I _{IO}	V _{IC} = 0, R _S = 50 Ω	25°C	0.006	0.006	0.006	0.006	0.006	0.006	0.006	0.006	μV/mo	
Input offset current		25°C	0.5	0.4	6	0.5	0.4	6	0.3	6	nA	
I _{IB}		Full range	10	10	10	10	10	10	10	10	nA	
V _{ICR}	R _S = 50 Ω	25°C	35	33	70	35	33	70	30	70	nA	
		Full range	90	90	90	90	90	90	90	90	nA	
		25°C	-15 to 13.5	-15.3 to 14	-15 to 14	-15 to 13.5	-15.3 to 14	-15 to 14	-15 to 13.5	-15.3 to 14	-15 to 14	V
V _{OM+}	R _L = 10 kΩ	Full range	-15 to 13.5	-15 to 13.5	-15 to 13.5	-15 to 13.5	-15 to 13.5	-15 to 13.5	-15 to 13.5	-15 to 13.5	V	
Maximum positive peak output voltage swing		25°C	14	14.3	14	14	14.3	14	14.3	14	V	
V _{OM-}		Full range	13.9	13.9	13.9	13.9	13.9	13.9	13.9	13.9	V	
A _{V/D}	V _O = ±10 V, R _L = 10 kΩ	25°C	-13.7 to -13.7	-14.1 to -14.1	-13.7 to -13.7	-13.7 to -13.7	-14.1 to -14.1	-13.7 to -13.7	-13.7 to -13.7	-13.7 to -13.7	V	
CMRR	V _{IC} = V _{ICRmin} , R _S = 50 Ω	25°C	0.8	4	1	0.8	4	1	1.5	10	V/μV	
		Full range	0.8	1	1	0.8	1	1	1.5	1.5	V/μV	
k _{SVR}	V _{CC±} = ±2.5 V to ±15 V	25°C	95	106	97	95	106	97	100	112	dB	
		Full range	91	93	93	91	93	93	96	96	dB	
I _{CC}	V _O = 0, No load	25°C	100	115	103	100	115	103	105	120	dB	
		Full range	95	98	98	95	98	98	100	100	dB	
ΔI _{CC}	V _O = 0, No load	25°C	550	700	550	550	700	550	550	700	μA	
		Full range	700	700	700	700	700	700	700	700	μA	
Full range	Full range	9	9	9	9	9	9	9	9	μA		

† Full range is 0°C to 70°C.

NOTE 4: Typical values are based on the input offset voltage shift observed through 168 hours of operating life test at T_A = 150°C extrapolated to T_A = 25°C using the Arrhenius equation and assuming an activation energy of 0.96 eV.

TLE202x, TLE202xA, TLE202xB, TLE202xY EXCALIBUR HIGH-SPEED LOW-POWER PRECISION OPERATIONAL AMPLIFIERS

SLOS191C – FEBRUARY 1997 – REVISED APRIL 2007

TLE2024 electrical characteristics at specified free-air temperature, $V_{CC} = 5\text{ V}$ (unless otherwise noted)

PARAMETER	TEST CONDITIONS	T_A †	TLE2024C			TLE2024AC			TLE2024BC			UNIT
			MIN	TYP	MAX	MIN	TYP	MAX	MIN	TYP	MAX	
V_{IO}	$V_{IC} = 0, R_S = 50\ \Omega$	25°C	1100		850						600	μV
α_{VIO}		Full range	1300		1050						800	$\mu\text{V}/^\circ\text{C}$
Input offset voltage long-term drift (see Note 4)		Full range	2								2	$\mu\text{V}/^\circ\text{C}$
I_{IO}	$V_{IC} = 0, R_S = 50\ \Omega$	25°C	0.005		0.005						0.005	$\mu\text{V}/\text{mo}$
Input offset current		25°C	0.6	6	0.5	6	0.4	6				nA
Input bias current		Full range	10		10						10	nA
V_{ICR}	$R_S = 50\ \Omega$	25°C	0	-0.3 to 3.5	0	-0.3 to 3.5	0	-0.3 to 3.5	0	-0.3 to 3.5	0	V
		Full range	0	to 3.5	0	to 3.5	0	to 3.5	0	to 3.5	0	V
		Full range	3.9	4.2	3.9	4.2	4	4.3	4	4.3	4	V
V_{OH}	$R_L = 10\ \text{k}\Omega$	25°C	3.7		3.7						3.8	V
High-level output voltage		Full range	3.7		3.7						3.8	V
Low-level output voltage		25°C	0.7	0.8	0.7	0.8	0.7	0.8	0.7	0.8	0.8	V
A_{VD}	$V_O = 1.4\text{ V to }4\text{ V}, R_L = 10\ \text{k}\Omega$	Full range	0.95		0.95						0.95	V
Large-signal differential voltage amplification		25°C	0.2	1.5	0.3	1.5	0.4	1.5	0.4	1.5	1.5	V/ μV
Common-mode rejection ratio		Full range	0.1		0.1		0.1		0.1		0.1	V/ μV
CMRR	$V_{IC} = V_{ICR\text{min}}, R_S = 50\ \Omega$	25°C	80	90	82	92	85	95	85	95	95	dB
Common-mode rejection ratio		Full range	80		82		82		85		85	dB
Supply-voltage rejection ratio		25°C	98	112	100	115	103	117	103	117	117	dB
kSVR	$V_{CC} = 5\text{ V to }30\text{ V}$	Full range	93		95						98	dB
Supply current		25°C	800	1200	800	1200	800	1200	800	1200	1200	μA
Supply current change over operating temperature range		Full range	1200		1200		1200		1200		1200	μA
ΔI_{CC}	$V_O = 2.5\text{ V}, \text{No load}$	Full range	15		15						15	μA
Supply current change over operating temperature range		Full range	15		15						15	μA

† Full range is 0°C to 70°C.

NOTE 4: Typical values are based on the input offset voltage shift observed through 168 hours of operating life test at $T_A = 150^\circ\text{C}$ extrapolated to $T_A = 25^\circ\text{C}$ using the Arrhenius equation and assuming an activation energy of 0.96 eV.



TLE202x, TLE202xA, TLE202xB, TLE202xY EXCALIBUR HIGH-SPEED LOW-POWER PRECISION OPERATIONAL AMPLIFIERS

SLOS191C – FEBRUARY 1997 – REVISED APRIL 2007

TLE2024 electrical characteristics at specified free-air temperature, $V_{CC} = \pm 15\text{ V}$ (unless otherwise noted)

PARAMETER	TEST CONDITIONS	T_A^\dagger	TLE2024C			TLE2024AC			TLE2024BC			UNIT
			MIN	TYP	MAX	MIN	TYP	MAX	MIN	TYP	MAX	
V_{IO}	$V_{IC} = 0, R_S = 50\ \Omega$	25°C	1000		750					500	μV	
α_{VIO}		Full range	1200		950					700		
Input offset voltage long-term drift (see Note 4)		Full range	2		2					2	$\mu\text{V}/^\circ\text{C}$	
I_{IO}	$V_{IC} = 0, R_S = 50\ \Omega$	25°C	0.006		0.006					0.006	$\mu\text{V}/\text{mo}$	
I_{IB}		25°C	0.6	6	6	0.5	6	6	0.4	6	nA	
Input bias current		Full range	10	10	10	10	10	10	10	10		
V_{ICR}	$R_S = 50\ \Omega$	25°C	-15 to 13.5	-15.3 to 14	-15 to 13.5	-15 to 13.5	-15.3 to 14	-15 to 13.5	-15 to 13.5	-15.3 to 14	V	
Common-mode input voltage range		Full range	-15 to 13.5	-15 to 13.5	-15 to 13.5	-15 to 13.5	-15 to 13.5	-15 to 13.5	-15 to 13.5	-15 to 13.5		
V_{OM+}		25°C	13.8	14.1	13.9	14.2	14	14.3	13.9	14.3	V	
Maximum positive peak output voltage swing	$R_L = 10\ \text{k}\Omega$	Full range	13.7		13.8							
V_{OM-}		25°C	-13.7	-14.1	-13.7	-14.1	-13.7	-14.1	-13.7	-14.1	V	
Large-signal differential voltage amplification		Full range	-13.6		-13.6							
A_V/D	$V_O = \pm 10\ \text{V}, R_L = 10\ \text{k}\Omega$	25°C	0.4	2	0.8	4	1	7	1	7	$\text{V}/\mu\text{V}$	
Common-mode rejection ratio		Full range	0.4		0.8							
CMRR		25°C	92	102	94	105	97	108	93	108	dB	
kSVR	$V_{CC\pm} = \pm 2.5\ \text{V to } \pm 15\ \text{V}$	Full range	88		90							
Supply current		25°C	98	112	100	115	103	117	98	117	dB	
Supply current change over operating temperature range		Full range	93		95							
I_{CC}	No load	25°C	1050	1400	1050	1400	1050	1400	1050	1400	μA	
ΔI_{CC}		Full range	1400	1400	1400	1400	1400	1400	1400	1400		
Supply current change over operating temperature range		Full range	20		20					20	μA	

† Full range is 0°C to 70°C.

NOTE 4: Typical values are based on the input offset voltage shift observed through 168 hours of operating life test at $T_A = 150^\circ\text{C}$ extrapolated to $T_A = 25^\circ\text{C}$ using the Arrhenius equation and assuming an activation energy of 0.96 eV.



TLE202x, TLE202xA, TLE202xB, TLE202xY EXCALIBUR HIGH-SPEED LOW-POWER PRECISION OPERATIONAL AMPLIFIERS

SLOS191C – FEBRUARY 1997 – REVISED APRIL 2007

TLE2021 electrical characteristics at specified free-air temperature, $V_{CC} = 5\text{ V}$ (unless otherwise noted)

PARAMETER	TEST CONDITIONS	T_A †	TLE2021I			TLE2021AI			TLE2021BI			UNIT
			MIN	TYP	MAX	MIN	TYP	MAX	MIN	TYP	MAX	
V_{IO} Input offset voltage		25°C	120	600	300	100	300	80	200	300	μV	
α_{VIO} Temperature coefficient of input offset voltage		Full range	2			2		2			$\mu\text{V}/^\circ\text{C}$	
Input offset voltage long-term drift (see Note 4)	$V_{IC} = 0, R_S = 50\ \Omega$	25°C	0.005			0.005		0.005			$\mu\text{V}/\text{mo}$	
I_{IO} Input offset current		25°C	0.2	6	6	0.2	6	0.2	6	6	nA	
		Full range	10		10	10		10		10		
I_{IB} Input bias current		25°C	25	70	70	25	70	25	70	70	nA	
		Full range	90		90	90		90		90		
V_{ICR} Common-mode input voltage range	$R_S = 50\ \Omega$	25°C	0 to 3.5	-0.3 to 4	0 to 3.5	-0.3 to 4	0 to 3.5	-0.3 to 4	0 to 3.5	-0.3 to 4	V	
		Full range	0 to 3.2		0 to 3.2		0 to 3.2		0 to 3.2			
V_{OH} High-level output voltage		25°C	4	4.3		4	4.3	4	4.3		V	
		Full range	3.9			3.9		3.9				
V_{OL} Low-level output voltage		25°C	0.7	0.8		0.7	0.8	0.7	0.8		V	
		Full range	0.9			0.9		0.9				
A_{VD} Large-signal differential voltage amplification	$V_O = 1.4\text{ V to }4\text{ V}, R_L = 10\text{ k}\Omega$	25°C	0.3	1.5		0.3	1.5	0.3	1.5		V/ μV	
		Full range	0.25			0.25		0.25				
CMRR Common-mode rejection ratio	$V_{IC} = V_{ICR}\text{ min}, R_S = 50\ \Omega$	25°C	85	110		85	110	85	110		dB	
		Full range	80			80		80				
kSVR Supply-voltage rejection ratio ($\Delta V_{CC}/\Delta V_{IO}$)	$V_{CC} = 5\text{ V to }30\text{ V}$	25°C	105	120		105	120	105	120		dB	
		Full range	100			100		100				
I_{CC} Supply current	$V_O = 2.5\text{ V},$ No load	25°C	200	300	300	200	300	200	300	300	μA	
		Full range	300		300	300		300		300		
ΔI_{CC} Supply-current change over operating temperature range		Full range	6			6		6			μA	

† Full range is -40°C to 85°C .
 NOTE 4: Typical values are based on the input offset voltage shift observed through 168 hours of operating life test at $T_A = 150^\circ\text{C}$ extrapolated to $T_A = 25^\circ\text{C}$ using the Arrhenius equation and assuming an activation energy of 0.96 eV.



TLE202x, TLE202xA, TLE202xB, TLE202xY EXCALIBUR HIGH-SPEED LOW-POWER PRECISION OPERATIONAL AMPLIFIERS

SLOS191C – FEBRUARY 1997 – REVISED APRIL 2007

TLE2021 electrical characteristics at specified free-air temperature, $V_{CC} = \pm 15\text{ V}$ (unless otherwise noted)

PARAMETER	TEST CONDITIONS	TA†	TLE2021I			TLE2021AI			TLE2021BI			UNIT
			MIN	TYP	MAX	MIN	TYP	MAX	MIN	TYP	MAX	
V _{IO} Input offset voltage		25°C	120	500	200	80	200	40	100			μV
		Full range		850	500			200				
α _{VIO} Temperature coefficient of input offset voltage		Full range	2			2		2				μV/°C
		25°C	0.006			0.006		0.006				
I _{IO} Input offset current	V _{IC} = 0, R _S = 50 Ω	25°C	0.2	6	6	0.2	6	0.2	6			nA
		Full range		10	10		10		10			
I _{IB} Input bias current		25°C	25	70	70	25	70	25	70			nA
		Full range		90	90		90		90			
V _{ICR} Common-mode input voltage range	R _S = 50 Ω	25°C	-15 to 13.5	-15.3 to 14	-15 to 13.2	-15 to 13.5	-15.3 to 14	-15 to 13.2	-15.3 to 14			V
		Full range		-15 to 13.2			-15 to 13.2					
V _{OM+} Maximum positive peak output voltage swing	R _L = 10 kΩ	25°C	14	14.3	14	14	14.3	14	14.3			V
		Full range		13.9	13.9		13.9		13.9			
V _{OM-} Maximum negative peak output voltage swing		25°C	-13.7	-14.1	-13.7	-13.7	-14.1	-13.7	-14.1			V
		Full range		-13.6	-13.6		-13.6		-13.6			
A _{V/D} Large-signal differential voltage amplification	V _O = 10 V, R _L = 10 kΩ	25°C	1	6.5	1	1	6.5	1	6.5			V/μV
		Full range		0.75	0.75		0.75		0.75			
CMRR Common-mode rejection ratio	V _{IC} = V _{ICR} min, R _S = 50 Ω	25°C	100	115	100	100	115	100	115			dB
		Full range		96	96		96		96			
k _{SVR} Supply-voltage rejection ratio (ΔV _{CC} /ΔV _{IO})	V _{CC±} = ±2.5 V to ±15 V	25°C	105	120	105	105	120	105	120			dB
		Full range		100	100		100		100			
I _{CC} Supply current	V _O = 0 V, No load	25°C	240	350	240	240	350	240	350			μA
		Full range		350	350		350		350			
ΔI _{CC} Supply-current change over operating temperature range		Full range	7			7		7				μA
		25°C										

† Full range is -40°C to 85°C.
NOTE 4: Typical values are based on the input offset voltage shift observed through 168 hours of operating life test at T_A = 150°C extrapolated to T_A = 25°C using the Arrhenius equation and assuming an activation energy of 0.96 eV.



TLE202x, TLE202xA, TLE202xB, TLE202xY EXCALIBUR HIGH-SPEED LOW-POWER PRECISION OPERATIONAL AMPLIFIERS

SLOS191C – FEBRUARY 1997 – REVISED APRIL 2007

TLE2022 electrical characteristics at specified free-air temperature, $V_{CC} = 5\text{ V}$ (unless otherwise noted)

PARAMETER	TEST CONDITIONS	TA †	TLE2022I			TLE2022AI			TLE2022BI			UNIT
			MIN	TYP	MAX	MIN	TYP	MAX	MIN	TYP	MAX	
V_{IO}	$V_{IC} = 0, R_S = 50\ \Omega$	25°C			600			400			250	μV
α_{VIO}		Full range			800			550			400	
Input offset voltage long-term drift (see Note 4)		Full range		2			2			2		$\mu\text{V}/^\circ\text{C}$
I_{IO}	$V_{IC} = 0, R_S = 50\ \Omega$	25°C	0.005			0.005			0.005			$\mu\text{V}/\text{mo}$
Input offset current		25°C	0.5	6		0.4	6		0.3	6		nA
Input bias current		Full range		10			10			10		
V_{ICR}	$R_S = 50\ \Omega$	25°C	0	-0.3 to 3.5	4	0	-0.3 to 3.5	4	0	-0.3 to 3.5	4	V
		Full range		0 to 3.2			0 to 3.2			0 to 3.2		
		25°C	4	4.3		4	4.3		4	4.3		V
V_{OH}	$R_L = 10\ \text{k}\Omega$	25°C	3.9			3.9			3.9			V
		Full range		0.7	0.8		0.7	0.8		0.7	0.8	
V_{OL}	$R_L = 10\ \text{k}\Omega$	25°C	0.3	1.5		0.4	1.5		0.5	1.5		V
		Full range		0.2			0.2			0.2		
A_{VD}	$V_O = 1.4\text{ V to }4\text{ V}, R_L = 10\ \text{k}\Omega$	25°C	85	100		87	102		90	105		$\text{V}/\mu\text{V}$
CMRR	$V_{IC} = V_{ICRmin}, R_S = 50\ \Omega$	25°C	80			82			85			dB
		Full range		100	115		103	118		105	120	
kSVR	$V_{CC} = 5\text{ V to }30\text{ V}$	25°C	95			98			100			dB
I_{CC}	$V_O = 2.5\text{ V}, \text{ No load}$	25°C	450	600		450	600		450	600		μA
		Full range		600			600			600		
ΔI_{CC}		Full range		15			15			15		μA

† Full range is -40°C to 85°C .
 NOTE 4: Typical values are based on the input offset voltage shift observed through 168 hours of operating life test at $T_A = 150^\circ\text{C}$ extrapolated to $T_A = 25^\circ\text{C}$ using the Arrhenius equation and assuming an activation energy of 0.96 eV.



TLE202x, TLE202xA, TLE202xB, TLE202xY EXCALIBUR HIGH-SPEED LOW-POWER PRECISION OPERATIONAL AMPLIFIERS

SLOS191C – FEBRUARY 1997 – REVISED APRIL 2007

TLE2022 electrical characteristics at specified free-air temperature, $V_{CC} = \pm 15\text{ V}$ (unless otherwise noted)

PARAMETER	TEST CONDITIONS	T _A †	TLE2022I			TLE2022AI			TLE2022BI			UNIT	
			MIN	TYP	MAX	MIN	TYP	MAX	MIN	TYP	MAX		
V _{IO}	V _I C = 0, R _S = 50 Ω	25°C	150	150	500	120	120	300	70	70	150	μV	
		Full range			700			450			300		
α _{VIO}		Full range		2			2			2		μV/°C	
I _{IO}	V _I C = 0, R _S = 50 Ω	25°C	0.006	0.006	6	0.006	0.006	6	0.006	0.006	6	μV/mo	
		Full range		0.5		10			10		10	nA	
I _{IB}		Full range		35	70	90	33	70	90	30	70	90	nA
V _{ICR}	R _S = 50 Ω	25°C	-15 to 13.5	-15.3 to 14	-15 to 13.2	-15 to 13.5	-15.3 to 14	-15 to 13.2	-15 to 13.5	-15.3 to 14	-15 to 13.2	V	
		Full range		-15 to 13.2			-15 to 13.2			-15 to 13.2			
V _{OM+}		Full range		14	14.3	14	14	14.3	14	14	14.3	V	
V _{OM-}	R _L = 10 kΩ	25°C	13.9	13.9	13.9	13.9	13.9	13.9	13.9	13.9	13.9	V	
		Full range		-13.7 to -13.6	-14.1 to -13.6	-13.7 to -13.6	-13.7 to -13.6	-14.1 to -13.6	-13.7 to -13.6	-13.7 to -14.1	-13.7 to -13.6	V	
A _{V/D}		Full range		0.8	4	0.8	1	7	1	1.5	10	V/μV	
CMRR	V _I C = V _{ICRmin} , R _S = 50 Ω	25°C	95	106	97	109	109	109	100	112	100	dB	
		Full range		91		93			96		96		
k _{SVR}		Full range		100	115	103	118	118	105	120	105	120	dB
I _{CC}	V _O = 0, No load	25°C	550	700	550	700	700	700	550	700	550	700	μA
		Full range		550	700	700	700	700	550	700	550	700	μA
ΔI _{CC}		Full range		30			30			30		30	μA

† Full range is -40°C to 85°C.
NOTE 4: Typical values are based on the input offset voltage shift observed through 168 hours of operating life test at T_A = 150°C extrapolated to T_A = 25°C using the Arrhenius equation and assuming an activation energy of 0.96 eV.

TLE202x, TLE202xA, TLE202xB, TLE202xY EXCALIBUR HIGH-SPEED LOW-POWER PRECISION OPERATIONAL AMPLIFIERS

SLOS191C – FEBRUARY 1997 – REVISED APRIL 2007

TLE2024 electrical characteristics at specified free-air temperature, $V_{CC} = 5\text{ V}$ (unless otherwise noted)

PARAMETER	TEST CONDITIONS	T_A †	TLE2024I		TLE2024AI		TLE2024BI		UNIT
			MIN	TYP	MAX	MIN	TYP	MAX	
V_{IO}	$V_{IC} = 0$, $R_S = 50\ \Omega$	25°C	1100		850		600		μV
α_{VIO}		Full range	1300		1050		800		
Input offset voltage long-term drift (see Note 4)		Full range	2		2		2		$\mu\text{V}/^\circ\text{C}$
I_{IO}	$V_{IC} = 0$, $R_S = 50\ \Omega$	25°C	0.005		0.005		0.005		$\mu\text{V}/\text{mo}$
Input offset current		25°C	0.6	6	0.5	6	0.4	6	nA
Input bias current		Full range	10		10		10		
V_{ICR}	$R_S = 50\ \Omega$	25°C	45	70	40	70	35	70	nA
		Full range	90		90		90		
		25°C	0	-0.3 to 3.5	0	-0.3 to 3.5	0	-0.3 to 3.5	
Common-mode input voltage range		Full range	0 to 3.2	0 to 3.2	0 to 3.2	0 to 3.2	0 to 3.2	V	
V_{OM+}	$R_L = 10\ \text{k}\Omega$	25°C	3.9	4.2	3.9	4.2	4	4.3	V
Maximum positive peak output voltage swing		Full range	3.7		3.7		3.8		
V_{OM-}	$R_L = 10\ \text{k}\Omega$	25°C	0.7	0.8	0.7	0.8	0.7	0.8	V
Maximum negative peak output voltage swing		Full range	0.95		0.95		0.95		
A_{VD}	$V_O = 1.4\text{ V to }4\text{ V}$, $R_L = 10\ \text{k}\Omega$	25°C	0.2	1.5	0.3	1.5	0.4	1.5	$\text{V}/\mu\text{V}$
Large-signal differential voltage amplification		Full range	0.1		0.1		0.1		
CMRR	$V_{IC} = V_{ICR\text{min}}$, $R_S = 50\ \Omega$	25°C	80	90	82	92	85	95	dB
Common-mode rejection ratio		Full range	80		82		85		
kSVR	$V_{CC\pm} = \pm 2.5\text{ V to } \pm 15\text{ V}$	25°C	98	112	100	115	103	117	dB
Supply-voltage rejection ratio ($\Delta V_{CC\pm}/\Delta V_{IO}$)		Full range	93		95		98		
I_{CC}	No load	25°C	800	1200	800	1200	800	1200	μA
Supply current		Full range	1200		1200		1200		
ΔI_{CC}	No load	25°C	30		30		30		μA
Supply current change over operating temperature range		Full range							

† Full range is -40°C to 85°C .
 NOTE 4: Typical values are based on the input offset voltage shift observed through 168 hours of operating life test at $T_A = 150^\circ\text{C}$ extrapolated to $T_A = 25^\circ\text{C}$ using the Arrhenius equation and assuming an activation energy of 0.96 eV.



TLE202x, TLE202xA, TLE202xB, TLE202xY EXCALIBUR HIGH-SPEED LOW-POWER PRECISION OPERATIONAL AMPLIFIERS

SLOS191C – FEBRUARY 1997 – REVISED APRIL 2007

TLE2024 electrical characteristics at specified free-air temperature, $V_{CC} = \pm 15\text{ V}$ (unless otherwise noted)

PARAMETER	TEST CONDITIONS	T_A^\dagger	TLE2024I			TLE2024AI			TLE2024BI			UNIT
			MIN	TYP	MAX	MIN	TYP	MAX	MIN	TYP	MAX	
V_{IO}	$V_{IC} = 0, R_S = 50\ \Omega$	25°C	1000		750					500	μV	
		Full range	1200		950					700		
α_{VIO}		Full range	2			2				2	$\mu\text{V}/^\circ\text{C}$	
Input offset voltage long-term drift (see Note 4)		25°C	0.006		0.006				0.006	$\mu\text{V}/\text{mo}$		
I_{IO}	$V_{IC} = 0, R_S = 50\ \Omega$	25°C	0.6		6				0.4	6	nA	
		Full range	10		10				10	10		
I_{IB}		25°C	50		70				40	70	nA	
		Full range	90		90				90	90	nA	
V_{ICR}	$R_S = 50\ \Omega$	25°C	-15 to 13.5	-15.3 to 14	-15 to 13.5	-15.3 to 14	-15 to 13.5	-15.3 to 14	-15 to 13.5	-15.3 to 14	V	
		Full range	-15 to 13.2	-15 to 13.2	-15 to 13.2	-15 to 13.2	-15 to 13.2	-15 to 13.2	-15 to 13.2	-15 to 13.2		
V_{OM+}		25°C	13.8	14.1	13.9	14.2	14	14.3	14	14.3	V	
		Full range	13.7		13.7			13.8				
V_{OM-}	$R_L = 10\ \text{k}\Omega$	25°C	-13.7	-14.1	-13.7	-14.1	-13.7	-14.1	-13.7	-14.1	V	
		Full range	-13.6		-13.6		-13.6		-13.6			
A_V/D		25°C	0.4	2	0.8	4	1	7	1	7	$\text{V}/\mu\text{V}$	
		Full range	0.4		0.8			1				
CMRR	$V_O = \pm 10\ \text{V}, R_L = 10\ \text{k}\Omega$	25°C	92	102	94	105	97	108			dB	
		Full range	88		90		93					
kSVR	$V_{IC} = V_{ICRmin}, R_S = 50\ \Omega$	25°C	98	112	100	115	103	117			dB	
		Full range	93		95		98					
I_{CC}	$V_{CC\pm} = \pm 2.5\ \text{V to } \pm 15\ \text{V}$	25°C	1050	1400	1050	1400	1050	1400	1050	1400	μA	
		Full range	1400		1400		1400		1400	1400		
ΔI_{CC}		Full range	50		50		50		50		μA	

† Full range is -40°C to 85°C .
NOTE 4: Typical values are based on the input offset voltage shift observed through 168 hours of operating life test at $T_A = 150^\circ\text{C}$ extrapolated to $T_A = 25^\circ\text{C}$ using the Arrhenius equation and assuming an activation energy of 0.96 eV.



TLE202x, TLE202xA, TLE202xB, TLE202xY
EXCALIBUR HIGH-SPEED LOW-POWER PRECISION
OPERATIONAL AMPLIFIERS

SLOS191C – FEBRUARY 1997 – REVISED APRIL 2007

TLE2021 electrical characteristics at specified free-air temperature, $V_{CC} = 5\text{ V}$ (unless otherwise noted)

PARAMETER	TEST CONDITIONS	T_A †	TLE2021M			TLE2021AM			TLE2021BM			UNIT
			MIN	TYP	MAX	MIN	TYP	MAX	MIN	TYP	MAX	
V_{IO}	Input offset voltage	25°C	120	600	300	100	300	80	200	300	μV	
α_{VIO}	Temperature coefficient of input offset voltage	Full range	1100									$\mu\text{V}/^\circ\text{C}$
	Input offset voltage long-term drift (see Note 4)	Full range	2									$\mu\text{V}/^\circ\text{C}$
I_{IO}	Input offset current	25°C	0.005									$\mu\text{V}/\text{mo}$
		25°C	0.2	6	6	0.2	6	0.2	6	6	nA	
		Full range	10									nA
I_{IB}	Input bias current	25°C	25	70	70	25	70	25	70	70	nA	
		Full range	90									nA
V_{ICR}	Common-mode input voltage range	25°C	0	-0.3		0	-0.3	0	-0.3		V	
		Full range	to	to		to	to	to	to			
			3.5	4		3.5	4	3.5	4			
			0			0		0				
			to			to		to				
			3.2			3.2		3.2				
V_{OH}	High-level output voltage	25°C	4	4.3		4	4.3	4	4.3		V	
		Full range	3.8									V
V_{OL}	Low-level output voltage	25°C	0.7	0.8		0.7	0.8	0.7	0.8		V	
		Full range	0.95									V
A_{VD}	Large-signal differential voltage amplification	25°C	0.3	1.5		0.3	1.5	0.3	1.5		V/ μV	
		Full range	0.1									V/ μV
CMRR	Common-mode rejection ratio	25°C	85	110		85	110	85	110		dB	
		Full range	80									dB
kSVR	Supply-voltage rejection ratio ($\Delta V_{CC\pm}/\Delta V_{IO}$)	25°C	105	120		105	120	105	120		dB	
		Full range	100									dB
I_{CC}	Supply current	25°C	170	230		170	230	170	230		μA	
		Full range	230									μA
ΔI_{CC}	Supply current change over operating temperature range	Full range	9									μA

† Full range is -55°C to 125°C .
 NOTE 4: Typical values are based on the input offset voltage shift observed through 168 hours of operating life test at $T_A = 150^\circ\text{C}$ extrapolated to $T_A = 25^\circ\text{C}$ using the Arrhenius equation and assuming an activation energy of 0.96 eV.



TLE202x, TLE202xA, TLE202xB, TLE202xY EXCALIBUR HIGH-SPEED LOW-POWER PRECISION OPERATIONAL AMPLIFIERS

SLOS191C – FEBRUARY 1997 – REVISED APRIL 2007

TLE2021 electrical characteristics at specified free-air temperature, $V_{CC} = \pm 15\text{ V}$ (unless otherwise noted)

PARAMETER	TEST CONDITIONS	T _A †	TLE2021M			TLE2021AM			TLE2021BM			UNIT
			MIN	TYP	MAX	MIN	TYP	MAX	MIN	TYP	MAX	
V _{IO} Input offset voltage		25°C	120	500	200	80	200	100	40	100	100	μV
		Full range	1000		500			200			200	
α _{VIO} Temperature coefficient of input offset voltage		Full range	2		2		2		2		μV/°C	
Input offset voltage long-term drift (see Note 4)	V _{IC} = 0, R _S = 50 Ω	25°C	0.006		0.006		0.006		0.006		μV/mo	
		25°C	0.2	6	6	0.2	6	6	0.2	6	6	
I _{IO} Input offset current		Full range	10		10		10		10		nA	
		25°C	25	70	70	25	70	70	25	70	70	
I _{IB} Input bias current		Full range	90		90		90		90		nA	
		25°C	15	15.3	15.3	15	15.3	15.3	15	15.3	15.3	
V _{ICR} Common-mode input voltage range	R _S = 50 Ω	25°C	13.5	14	13.5	14	13.5	14	13.5	14	V	
		Full range	15	15.3	15.3	15	15.3	15.3	15	15.3	15.3	
V _{OM+} Maximum positive peak output voltage swing	R _L = 10 kΩ	25°C	14	14.3	14	14.3	14	14.3	14	14.3	V	
		Full range	13.8		13.8		13.8		13.8		13.8	
V _{OM-} Maximum negative peak output voltage swing		25°C	13.7	14.1	13.7	14.1	13.7	14.1	13.7	14.1	V	
		Full range	13.6		13.6		13.6		13.6		13.6	
A _{V/D} Large-signal differential voltage amplification	V _O = ±10 V, R _L = 10 kΩ	25°C	1	6.5	1	6.5	1	6.5	1	6.5	V/μV	
		Full range	0.5		0.5		0.5		0.5		0.5	
CMRR Common-mode rejection ratio	V _{IC} = V _{ICRmin} , R _S = 50 Ω	25°C	100	115	100	115	100	115	100	115	dB	
		Full range	96		96		96		96		96	
k _{SVR} Supply-voltage rejection ratio (ΔV _{CC±} /ΔV _{IO})	V _{CC±} = ± 2.5 V to ± 15 V	25°C	105	120	105	120	105	120	105	120	dB	
		Full range	100		100		100		100		100	
I _{CC} Supply current	V _O = 0, No load	25°C	200	300	300	200	300	300	200	300	μA	
		Full range	300		300		300		300		300	
ΔI _{CC} Supply current change over operating temperature range		Full range	10		10		10		10		μA	

† Full range is -55°C to 125°C.

NOTE 4: Typical values are based on the input offset voltage shift observed through 168 hours of operating life test at T_A = 150°C extrapolated to T_A = 25°C using the Arrhenius equation and assuming an activation energy of 0.96 eV.



TLE202x, TLE202xA, TLE202xB, TLE202xY EXCALIBUR HIGH-SPEED LOW-POWER PRECISION OPERATIONAL AMPLIFIERS

SLOS191C – FEBRUARY 1997 – REVISED APRIL 2007

TLE2022 electrical characteristics at specified free-air temperature, $V_{CC} = 5\text{ V}$ (unless otherwise noted)

PARAMETER	TEST CONDITIONS	T_A †	TLE2022M			TLE2022AM			TLE2022BM			UNIT
			MIN	TYP	MAX	MIN	TYP	MAX	MIN	TYP	MAX	
V_{IO}		25°C			600			400			250	μV
		Full range			800			550			400	
α_{VIO}		Full range	2			2			2			$\mu\text{V}/^\circ\text{C}$
Input offset voltage long-term drift (see Note 4)	$V_{IC} = 0, R_S = 50\ \Omega$	25°C	0.005			0.005			0.005			$\mu\text{V}/\text{mo}$
I_{IO}		25°C	0.5	6		0.4	6		0.3	6		nA
		Full range		10			10			10		
I_{IB}		25°C	35	70		33	70		30	70		nA
		Full range		90			90			90		
V_{ICR}	$R_S = 50\ \Omega$	25°C	0 to 3.5	-0.3 to 4		0 to 3.2	-0.3 to 4		0 to 3.2	-0.3 to 4		V
		Full range										
V_{OH}		25°C	4	4.3		4	4.3		4	4.3		V
		Full range		3.8			3.8			3.8		
V_{OL}	$R_L = 10\ \text{k}\Omega$	25°C	0.7	0.8		0.7	0.8		0.7	0.8		V
		Full range		0.95			0.95			0.95		
A_{VD}	$V_O = 1.4\text{ V to }4\text{ V}, R_L = 10\ \text{k}\Omega$	25°C	0.3	1.5		0.4	1.5		0.5	1.5		V/ μV
		Full range		0.1			0.1			0.1		
$CMRR$	$V_{IC} = V_{ICRmin}, R_S = 50\ \Omega$	25°C	85	100		87	102		90	105		dB
		Full range		80			82			85		
k_{SVR}	$V_{CC} = 5\text{ V to }30\text{ V}$	25°C	100	115		103	118		105	120		dB
		Full range		95			98			100		
I_{CC}	$V_O = 2.5\text{ V},$ No load	25°C	450	600		450	600		450	600		μA
		Full range		600			600			600		
ΔI_{CC}		Full range	37			37			37			μA

† Full range is -55°C to 125°C .

NOTE 4: Typical values are based on the input offset voltage shift observed through 168 hours of operating life test at $T_A = 150^\circ\text{C}$ extrapolated to $T_A = 25^\circ\text{C}$ using the Arrhenius equation and assuming an activation energy of 0.96 eV.



TLE202x, TLE202xA, TLE202xB, TLE202xY EXCALIBUR HIGH-SPEED LOW-POWER PRECISION OPERATIONAL AMPLIFIERS

SLOS191C – FEBRUARY 1997 – REVISED APRIL 2007

TLE2022 electrical characteristics at specified free-air temperature, $V_{CC} = \pm 15$ V (unless otherwise noted)

PARAMETER	TEST CONDITIONS	T _A †	TLE2022M			TLE2022AM			TLE2022BM			UNIT
			MIN	TYP	MAX	MIN	TYP	MAX	MIN	TYP	MAX	
V _{IO}		25°C	150	150	500	120	120	300	70	70	150	μV
α _{VIO}		Full range			700			450			300	μV
		Full range		2			2			2		μV/°C
	V _{IC} = 0, R _S = 50 Ω	25°C		0.006			0.006			0.006		μV/mo
I _{IO}		25°C	0.5	0.5	6	0.4	0.4	6	0.3	0.3	6	nA
		Full range			10			10			10	nA
I _{IB}		25°C	35	35	70	33	33	70	30	30	70	nA
		Full range			90			90			90	nA
V _{ICR}		25°C	-15	-15.3		-15	-15.3		-15	-15.3		V
	R _S = 50 Ω	Full range		to			to			to		V
			13.5	14		13.5	14		13.5	14		V
			-15			-15			-15			V
			to			to			to			V
			13.2			13.2			13.2			V
V _{OM+}		25°C	14	14.3		14	14.3		14	14.3		V
	R _L = 10 kΩ	Full range										V
			13.9			13.9			13.9			V
V _{OM-}		25°C	-13.7	-14.1		-13.7	-14.1		-13.7	-14.1		V
		Full range										V
			-13.6			-13.6			-13.6			V
A _{V/D}		25°C	0.8	4		1	7		1.5	10		V/μV
	V _O = ±10 V, R _L = 10 kΩ	Full range										V/μV
			0.8			1			1.5			V/μV
CMRR		25°C	95	106		97	109		100	112		dB
	V _{IC} = V _{ICRmin} , R _S = 50 Ω	Full range										dB
			91			93			96			dB
kSVR		25°C	100	115		103	118		105	120		dB
	V _{CC±} = ±2.5 V to ±15 V	Full range										dB
			95			98			100			dB
I _{CC}		25°C	550	550	700	550	550	700	550	550	700	μA
	V _O = 0, No load	Full range			700			700			700	μA
ΔI _{CC}		Full range		60			60			60		μA

† Full range is 0°C to 70°C.

NOTE 4: Typical values are based on the input offset voltage shift observed through 168 hours of operating life test at T_A = 150°C extrapolated to T_A = 25°C using the Arrhenius equation and assuming an activation energy of 0.96 eV.

TLE202x, TLE202xA, TLE202xB, TLE202xY EXCALIBUR HIGH-SPEED LOW-POWER PRECISION OPERATIONAL AMPLIFIERS

SLOS191C – FEBRUARY 1997 – REVISED APRIL 2007

TLE2024 electrical characteristics at specified free-air temperature, $V_{CC} = 5\text{ V}$ (unless otherwise noted)

PARAMETER	TEST CONDITIONS	T_A †	TLE2024M			TLE2024AM			TLE2024BM			UNIT
			MIN	TYP	MAX	MIN	TYP	MAX	MIN	TYP	MAX	
V_{IO}	$V_{IC} = 0$, $R_S = 50\ \Omega$	25°C	1100		850						600	μV
Temperature coefficient of input offset voltage		Full range	1300		1050						800	$\mu\text{V}/^\circ\text{C}$
Input offset voltage long-term drift (see Note 4)		Full range	2								2	$\mu\text{V}/^\circ\text{C}$
I_{IO}	$V_{IC} = 0$, $R_S = 50\ \Omega$	25°C	0.005		0.005						0.005	$\mu\text{V}/\text{mo}$
Input offset current		25°C	0.6	6	6	0.5	6	6	0.4	6	6	nA
Input bias current		Full range	10		10						10	nA
I_{IB}	$R_S = 50\ \Omega$	25°C	45	70	70	40	70	35	70	70	70	nA
Common-mode input voltage range		Full range	90		90						90	nA
V_{ICR}		25°C	0	-0.3 to 3.5	0 to 4	-0.3 to 3.5	0 to 4	0 to 3.5	-0.3 to 4	0 to 3.5	0 to 4	V
V_{OM+}	$R_L = 10\ \text{k}\Omega$	Full range	0	to 3.2	0	to 3.2	0	to 3.2	0	to 3.2	0	V
Maximum positive peak output voltage swing		25°C	3.9	4.2	3.9	4.2	4	4.3	4	4.3	4	V
Maximum negative peak output voltage swing		Full range	3.7		3.7		3.8		3.8		3.8	V
A_{VD}	$V_O = 1.4\text{ V to }4\text{ V}$, $R_L = 10\ \text{k}\Omega$	25°C	0.7	0.8	0.7	0.8	0.7	0.8	0.7	0.8	0.8	V
Large-signal differential voltage amplification		Full range	0.95		0.95		0.95		0.95		0.95	V
Common-mode rejection ratio		25°C	0.2	1.5	0.3	1.5	0.4	1.5	0.4	1.5	1.5	V/ μV
CMRR	$V_{IC} = V_{ICR\text{min}}$, $R_S = 50\ \Omega$	Full range	0.1		0.1		0.1		0.1		0.1	V/ μV
Supply-voltage rejection ratio ($\Delta V_{CC\pm}/\Delta V_{IO}$)		25°C	80	90	82	92	85	95	85	95	95	dB
Supply current		Full range	80		82		85		85		85	dB
ΔI_{CC}	No load	25°C	98	112	100	115	103	117	103	117	117	dB
Supply current change over operating temperature range		Full range	93		95		98		98		98	dB
Supply current change over operating temperature range		25°C	800	1200	800	1200	800	1200	800	1200	1200	μA
Supply current change over operating temperature range	No load	Full range	1200		1200		1200		1200		1200	μA
Supply current change over operating temperature range		Full range	50		50		50		50		50	μA

† Full range is -55°C to 125°C.
NOTE 4: Typical values are based on the input offset voltage shift observed through 168 hours of operating life test at $T_A = 150^\circ\text{C}$ extrapolated to $T_A = 25^\circ\text{C}$ using the Arrhenius equation and assuming an activation energy of 0.96 eV.



TLE202x, TLE202xA, TLE202xB, TLE202xY EXCALIBUR HIGH-SPEED LOW-POWER PRECISION OPERATIONAL AMPLIFIERS

SLOS191C – FEBRUARY 1997 – REVISED APRIL 2007

TLE2024 electrical characteristics at specified free-air temperature, $V_{CC} = \pm 15\text{ V}$ (unless otherwise noted)

PARAMETER	TEST CONDITIONS	T_A^\dagger	TLE2024M			TLE2024AM			TLE2024BM			UNIT
			MIN	TYP	MAX	MIN	TYP	MAX	MIN	TYP	MAX	
V_{IO}	$V_{IC} = 0, R_S = 50\ \Omega$	25°C	1000		750						500	μV
		Full range	1200		950						700	
α_{VIO}		Full range	2			2					2	$\mu\text{V}/^\circ\text{C}$
Input offset voltage long-term drift (see Note 4)		25°C	0.006		0.006					0.006	$\mu\text{V}/\text{mo}$	
I_{IO}	$V_{IC} = 0, R_S = 50\ \Omega$	25°C	0.6	6	6	0.5	6	6	0.4	6	6	nA
		Full range	10		10						10	
I_{IB}		25°C	50	70	70	45	70	70	40	70	70	nA
	Full range	90		90						90		
V_{ICR}	$R_S = 50\ \Omega$	25°C	-15 to 13.5	-15.3 to 14	-15 to 13.5	-15.3 to 14	-15 to 13.5	-15.3 to 14	-15 to 13.5	-15.3 to 14		V
		Full range	-15 to 13.2		-15 to 13.2				-15 to 13.2			
V_{OM+}		25°C	13.8	14.1	13.9	14.2	14	14.3	13.8	14.3		V
	Full range	13.7		13.7				13.8				
V_{OM-}	$R_L = 10\ \text{k}\Omega$	25°C	-13.7	-14.1	-13.7	-14.1	-13.7	-14.1	-13.7	-14.1		V
		Full range	-13.6		-13.6				-13.6			
A_V/D		25°C	0.4	2	0.8	4	1	7	1	7		$\text{V}/\mu\text{V}$
	Full range	0.4		0.8				1				
$CMRR$	$V_O = \pm 10\ \text{V}, R_L = 10\ \text{k}\Omega$	25°C	92	102	94	105	97	108	93	108		dB
		Full range	88		90				93			
k_{SVR}		25°C	98	112	100	115	103	117	98	117		dB
	Full range	93		95				98				
I_{CC}	$V_{CC\pm} = \pm 2.5\ \text{V to } \pm 15\ \text{V}$	25°C	1050	1400	1050	1400	1050	1400	1050	1400		μA
		Full range	1400		1400				1400			
ΔI_{CC}		25°C	85		85				85			μA
	Full range											

† Full range is -55°C to 125°C .
NOTE 4: Typical values are based on the input offset voltage shift observed through 168 hours of operating life test at $T_A = 150^\circ\text{C}$ extrapolated to $T_A = 25^\circ\text{C}$ using the Arrhenius equation and assuming an activation energy of 0.96 eV.

TLE202x, TLE202xA, TLE202xB, TLE202xY
EXCALIBUR HIGH-SPEED LOW-POWER PRECISION
OPERATIONAL AMPLIFIERS

SLOS191C – FEBRUARY 1997 – REVISED APRIL 2007

TLE2021 operating characteristics, $V_{CC} = 5\text{ V}$, $T_A = 25^\circ\text{C}$

PARAMETER	TEST CONDITIONS	T_A	C SUFFIX			I SUFFIX			M SUFFIX			UNIT
			MIN	TYP	MAX	MIN	TYP	MAX	MIN	TYP	MAX	
SR	Slew rate at unity gain		0.5			0.5			0.5			V/ μs
V_n	Equivalent input noise voltage (see Figure 2)	25°C	21	50	50	21	21	50	21	21	50	nV/Hz
		25°C	17	30	30	17	17	30	17	17	30	nV/Hz
$V_{N(PP)}$	Peak-to-peak equivalent input noise voltage	25°C	0.16			0.16			0.16			μV
		25°C	0.47			0.47			0.47			μV
I_n	Equivalent input noise current	25°C	0.09			0.09			0.09			pA/Hz
B_1	Unity-gain bandwidth	25°C	1.2			1.2			1.2			MHz
ϕ_m	Phase margin at unity gain	25°C	42°			42°			42°			°

TLE2021 operating characteristics at specified free-air temperature, $V_{CC} = \pm 15\text{ V}$

PARAMETER	TEST CONDITIONS	T_A †	C SUFFIX			I SUFFIX			M SUFFIX			UNIT
			MIN	TYP	MAX	MIN	TYP	MAX	MIN	TYP	MAX	
SR	Slew rate at unity gain		0.45	0.65	0.65	0.45	0.65	0.65	0.45	0.65	0.65	V/ μs
V_n	Equivalent input noise voltage (see Figure 2)	25°C	0.45			0.42			0.45			V/ μs
		Full range	0.45			0.42			0.45			V/ μs
$V_{N(PP)}$	Peak-to-peak equivalent input noise voltage	25°C	19	50	50	19	19	50	19	19	50	nV/Hz
		25°C	15	30	30	15	15	30	15	15	30	nV/Hz
$V_{N(PP)}$	Peak-to-peak equivalent input noise voltage	25°C	0.16			0.16			0.16			μV
		25°C	0.47			0.47			0.47			μV
I_n	Equivalent input noise current	25°C	0.09			0.09			0.09			pA/Hz
B_1	Unity-gain bandwidth	25°C	2			2			2			MHz
ϕ_m	Phase margin at unity gain	25°C	46°			46°			46°			°

† Full range is 0°C to 70°C for the C-suffix devices, –40°C to 85°C for the I-suffix devices, and –55°C to 125°C for the M-suffix devices.



TLE202x, TLE202xA, TLE202xB, TLE202xY
EXCALIBUR HIGH-SPEED LOW-POWER PRECISION
OPERATIONAL AMPLIFIERS

SLOS191C – FEBRUARY 1997 – REVISED APRIL 2007

TLE2022 operating characteristics, $V_{CC} = 5\text{ V}$, $T_A = 25^\circ\text{C}$

PARAMETER	TEST CONDITIONS	C SUFFIX			I SUFFIX			M SUFFIX			UNIT
		MIN	TYP	MAX	MIN	TYP	MAX	MIN	TYP	MAX	
SR	Slew rate at unity gain	$V_O = 1\text{ V to }3\text{ V}$, See Figure 1									$\text{V}/\mu\text{s}$
V_n	Equivalent input noise voltage (see Figure 2)	$f = 10\text{ Hz}$									$\text{nV}/\sqrt{\text{Hz}}$
		$f = 1\text{ kHz}$									
$V_{N(PP)}$	Peak-to-peak equivalent input noise voltage	$f = 0.1\text{ to }1\text{ Hz}$									μV
		$f = 0.1\text{ to }10\text{ Hz}$									
I_n	Equivalent input noise current	0.1									$\text{pA}/\sqrt{\text{Hz}}$
B_1	Unity-gain bandwidth	1.7									MHz
ϕ_m	Phase margin at unity gain	47°									47°

TLE2022 operating characteristics at specified free-air temperature, $V_{CC} = \pm 15\text{ V}$

PARAMETER	TEST CONDITIONS	T_A^\dagger	C SUFFIX			I SUFFIX			M SUFFIX			UNIT
			MIN	TYP	MAX	MIN	TYP	MAX	MIN	TYP	MAX	
SR	Slew rate at unity gain	25°C	$V_O = \pm 10\text{ V}$, See Figure 1									$\text{V}/\mu\text{s}$
			Full range									
V_n	Equivalent input noise voltage (see Figure 2)	25°C	$f = 10\text{ Hz}$									$\text{nV}/\sqrt{\text{Hz}}$
			$f = 1\text{ kHz}$									
$V_{N(PP)}$	Peak-to-peak equivalent input noise voltage	25°C	$f = 0.1\text{ to }1\text{ Hz}$									μV
			$f = 0.1\text{ to }10\text{ Hz}$									
I_n	Equivalent input noise current	25°C	0.1									$\text{pA}/\sqrt{\text{Hz}}$
B_1	Unity-gain bandwidth	25°C	2.8									MHz
ϕ_m	Phase margin at unity gain	25°C	52°									52°

† Full range is 0°C to 70°C.



TLE202x, TLE202xA, TLE202xB, TLE202xY
EXCALIBUR HIGH-SPEED LOW-POWER PRECISION
OPERATIONAL AMPLIFIERS

SLOS191C – FEBRUARY 1997 – REVISED APRIL 2007

TLE2024 operating characteristics, $V_{CC} = 5\text{ V}$, $T_A = 25^\circ\text{C}$

PARAMETER	TEST CONDITIONS	C SUFFIX			I SUFFIX			M SUFFIX			UNIT
		MIN	TYP	MAX	MIN	TYP	MAX	MIN	TYP	MAX	
SR	Slew rate at unity gain	$V_O = 1\text{ V to }3\text{ V}$, See Figure 1									V/ μs
V_n	Equivalent input noise voltage (see Figure 2)	$f = 10\text{ Hz}$									nV/ $\sqrt{\text{Hz}}$
		$f = 1\text{ kHz}$									
$V_{N(PP)}$	Peak-to-peak equivalent input noise voltage	$f = 0.1\text{ to }1\text{ Hz}$									μV
		$f = 0.1\text{ to }10\text{ Hz}$									
I_n	Equivalent input noise current	0.1									pA/ $\sqrt{\text{Hz}}$
B_1	Unity-gain bandwidth	1.7									MHz
ϕ_m	Phase margin at unity gain	47°									47°

TLE2024 operating characteristics at specified free-air temperature, $V_{CC} = \pm 15\text{ V}$ (unless otherwise noted)

PARAMETER	TEST CONDITIONS	T_A^\dagger	C SUFFIX			I SUFFIX			M SUFFIX			UNIT
			MIN	TYP	MAX	MIN	TYP	MAX	MIN	TYP	MAX	
SR	Slew rate at unity gain	25°C	0.45	0.7		0.45	0.7		0.45	0.7		V/ μs
		Full range	0.45			0.42			0.4			
V_n	Equivalent input noise voltage (see Figure 2)	25°C	19	50		19	50		19	50		nV/ $\sqrt{\text{Hz}}$
		25°C	15	30		15	30		15	30		
$V_{N(PP)}$	Peak-to-peak equivalent input noise voltage	25°C	0.16			0.16			0.16			μV
		25°C	0.47			0.47			0.47			
I_n	Equivalent input noise current	25°C	0.1			0.1			0.1		pA/ $\sqrt{\text{Hz}}$	
B_1	Unity-gain bandwidth	25°C	2.8			2.8			2.8		MHz	
ϕ_m	Phase margin at unity gain	25°C	52°			52°			52°		52°	

† Full range is 0°C to 70°C.



TLE202x, TLE202xA, TLE202xB, TLE202xY
EXCALIBUR HIGH-SPEED LOW-POWER PRECISION
OPERATIONAL AMPLIFIERS

SLOS191C – FEBRUARY 1997 – REVISED APRIL 2007

TLE2021Y electrical characteristics at $V_{CC} = 5\text{ V}$, $T_A = 25^\circ\text{C}$ (unless otherwise noted)

PARAMETER	TEST CONDITIONS	TLE2021Y			UNIT
		MIN	TYP	MAX	
V_{IO} Input offset voltage	$V_{IC} = 0$, $R_S = 50\ \Omega$	150			μV
Input offset voltage long-term drift (see Note 4)		0.005			$\mu\text{V}/\text{mo}$
I_{IO} Input offset current		0.5			nA
I_{IB} Input bias current		35			nA
V_{ICR} Common-mode input voltage range	$R_S = 50\ \Omega$	-0.3 to 4			V
V_{OH} Maximum high-level output voltage	$R_L = 10\ \text{k}\Omega$	4.3			V
V_{OL} Maximum low-level output voltage		0.7			V
A_{VD} Large-signal differential voltage amplification	$V_O = 1.4\ \text{to}\ 4\ \text{V}$, $R_L = 10\ \text{k}\Omega$	1.5			$\text{V}/\mu\text{V}$
CMRR Common-mode rejection ratio	$V_{IC} = V_{ICR}\ \text{min}$, $R_S = 50\ \Omega$	100			dB
k_{SVR} Supply-voltage rejection ratio ($\Delta V_{CC\pm} / \Delta V_{IO}$)	$V_{CC} = 5\ \text{V}\ \text{to}\ 30\ \text{V}$	115			dB
I_{CC} Supply current	$V_O = 2.5\ \text{V}$, No load	400			μA

NOTE 4: Typical values are based on the input offset voltage shift observed through 168 hours of operating life test at $T_A = 150^\circ\text{C}$ extrapolated to $T_A = 25^\circ\text{C}$ using the Arrhenius equation and assuming an activation energy of 0.96 eV.

TLE2021Y operating characteristics at $V_{CC} = 5\ \text{V}$, $T_A = 25^\circ\text{C}$

PARAMETER	TEST CONDITIONS	TLE2021Y			UNIT
		MIN	TYP	MAX	
SR Slew rate at unity gain	$V_O = 1\ \text{V}\ \text{to}\ 3\ \text{V}$	0.5			$\text{V}/\mu\text{s}$
V_n Equivalent input noise voltage	$f = 10\ \text{Hz}$	21			$\text{nV}/\sqrt{\text{Hz}}$
	$f = 1\ \text{kHz}$	17			
$V_{N(PP)}$ Peak-to-peak equivalent input noise voltage	$f = 0.1\ \text{to}\ 1\ \text{Hz}$	0.16			μV
	$f = 0.1\ \text{to}\ 10\ \text{Hz}$	0.47			
I_n Equivalent input noise current		0.1			$\text{pA}/\sqrt{\text{Hz}}$
B_1 Unity-gain bandwidth		1.7			MHz
ϕ_m Phase margin at unity gain		47°			



TLE202x, TLE202xA, TLE202xB, TLE202xY EXCALIBUR HIGH-SPEED LOW-POWER PRECISION OPERATIONAL AMPLIFIERS

SLOS191C – FEBRUARY 1997 – REVISED APRIL 2007

TLE2022Y electrical characteristics, $V_{CC} = 5\text{ V}$, $T_A = 25^\circ\text{C}$ (unless otherwise noted)

PARAMETER	TEST CONDITIONS	TLE2022Y			UNIT
		MIN	TYP	MAX	
V_{IO} Input offset voltage	$V_{IC} = 0$, $R_S = 50\ \Omega$		150	600	μV
Input offset voltage long-term drift (see Note 4)			0.005		$\mu\text{V}/\text{mo}$
I_{IO} Input offset current			0.5		nA
I_{IB} Input bias current			35		nA
V_{ICR} Common-mode input voltage range	$R_S = 50\ \Omega$		-0.3 to 4		V
V_{OH} Maximum high-level output voltage	$R_L = 10\ \text{k}\Omega$		4.3		V
V_{OL} Maximum low-level output voltage			0.7		V
A_{VD} Large-signal differential voltage amplification	$V_O = 1.4\text{ to }4\text{ V}$, $R_L = 10\ \text{k}\Omega$		1.5		$\text{V}/\mu\text{V}$
CMRR Common-mode rejection ratio	$V_{IC} = V_{ICR}\ \text{min}$, $R_S = 50\ \Omega$		100		dB
k_{SVR} Supply-voltage rejection ratio ($\Delta V_{CC\pm} / \Delta V_{IO}$)	$V_{CC} = 5\text{ V to }30\text{ V}$		115		dB
I_{CC} Supply current	$V_O = 2.5\text{ V}$, No load		450		μA

NOTE 4: Typical values are based on the input offset voltage shift observed through 168 hours of operating life test at $T_A = 150^\circ\text{C}$ extrapolated to $T_A = 25^\circ\text{C}$ using the Arrhenius equation and assuming an activation energy of 0.96 eV.

TLE2022Y operating characteristics, $V_{CC} = 5\text{ V}$, $T_A = 25^\circ\text{C}$

PARAMETER	TEST CONDITIONS	TLE2022Y			UNIT
		MIN	TYP	MAX	
SR Slew rate at unity gain	$V_O = 1\text{ V to }3\text{ V}$, See Figure 1		0.5		$\text{V}/\mu\text{s}$
V_n Equivalent input noise voltage (see Figure 2)	$f = 10\ \text{Hz}$		21		$\text{nV}/\sqrt{\text{Hz}}$
	$f = 1\ \text{kHz}$		17		
$V_{N(PP)}$ Peak-to-peak equivalent input noise voltage	$f = 0.1\text{ to }1\ \text{Hz}$		0.16		μV
	$f = 0.1\text{ to }10\ \text{Hz}$		0.47		
I_n Equivalent input noise current			0.1		$\text{pA}/\sqrt{\text{Hz}}$
B_1 Unity-gain bandwidth	See Figure 3		1.7		MHz
ϕ_m Phase margin at unity gain	See Figure 3		47°		



TLE202x, TLE202xA, TLE202xB, TLE202xY EXCALIBUR HIGH-SPEED LOW-POWER PRECISION OPERATIONAL AMPLIFIERS

SLOS191C – FEBRUARY 1997 – REVISED APRIL 2007

TLE2024Y electrical characteristics, $V_{CC} = 5\text{ V}$, $T_A = 25^\circ\text{C}$ (unless otherwise noted)

PARAMETER	TEST CONDITIONS	TLE2024Y			UNIT
		MIN	TYP	MAX	
Input offset voltage long-term drift (see Note 4)			0.005		$\mu\text{V}/\text{mo}$
I_{IO} Input offset current	$V_{IC} = 0$, $R_S = 50\ \Omega$		0.6		nA
I_{IB} Input bias current			45		nA
V_{ICR} Common-mode input voltage range	$R_S = 50\ \Omega$		-0.3 to 4		V
V_{OH} High-level output voltage	$R_L = 10\ \text{k}\Omega$		4.2		V
V_{OL} Low-level output voltage			0.7		V
A_{VD} Large-signal differential voltage amplification	$V_O = 1.4\text{ V to }4\text{ V}$, $R_L = 10\ \text{k}\Omega$		1.5		$\text{V}/\mu\text{V}$
CMRR Common-mode rejection ratio	$V_{IC} = V_{ICR\text{min}}$, $R_S = 50\ \Omega$		90		dB
k_{SVR} Supply-voltage rejection ratio ($\Delta V_{CC}/\Delta V_{IO}$)	$V_{CC} = 5\text{ V to }30\text{ V}$		112		dB
I_{CC} Supply current	$V_O = 2.5\text{ V}$, No load		800		μA

NOTE 4. Typical values are based on the input offset voltage shift observed through 168 hours of operating life test at $T_A = 150^\circ\text{C}$ extrapolated to $T_A = 25^\circ\text{C}$ using the Arrhenius equation and assuming an activation energy of 0.96 eV.

TLE2024Y operating characteristics, $V_{CC} = 5\text{ V}$, $T_A = 25^\circ\text{C}$

PARAMETER	TEST CONDITIONS	TLE2024Y			UNIT
		MIN	TYP	MAX	
SR Slew rate at unity gain	$V_O = 1\text{ V to }3\text{ V}$, See Figure 1		0.5		$\text{V}/\mu\text{s}$
V_n Equivalent input noise voltage (see Figure 2)	$f = 10\text{ Hz}$		21		$\text{nV}/\sqrt{\text{Hz}}$
	$f = 1\text{ kHz}$		17		
$V_{N(PP)}$ Peak-to-peak equivalent input noise voltage	$f = 0.1\text{ to }1\text{ Hz}$		0.16		μV
	$f = 0.1\text{ to }10\text{ Hz}$		0.47		
I_n Equivalent input noise current			0.1		$\text{pA}/\sqrt{\text{Hz}}$
B_1 Unity-gain bandwidth	See Figure 3		1.7		MHz
ϕ_m Phase margin at unity gain	See Figure 3		47°		

PARAMETER MEASUREMENT INFORMATION

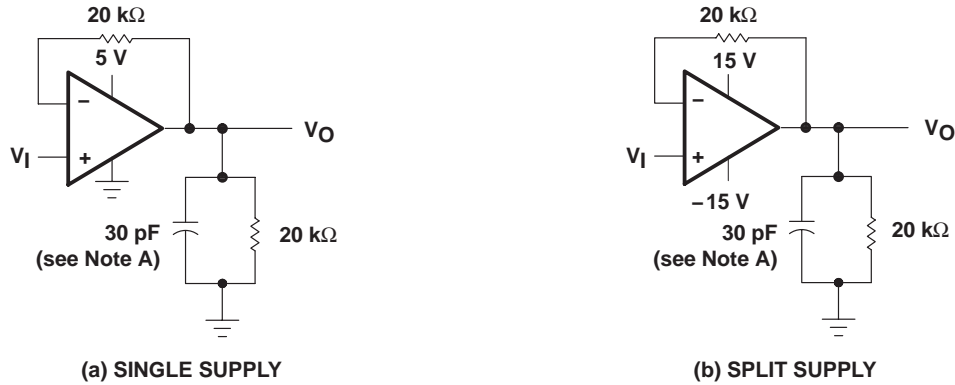

NOTE A: C_L includes fixture capacitance.

Figure 1. Slew-Rate Test Circuit

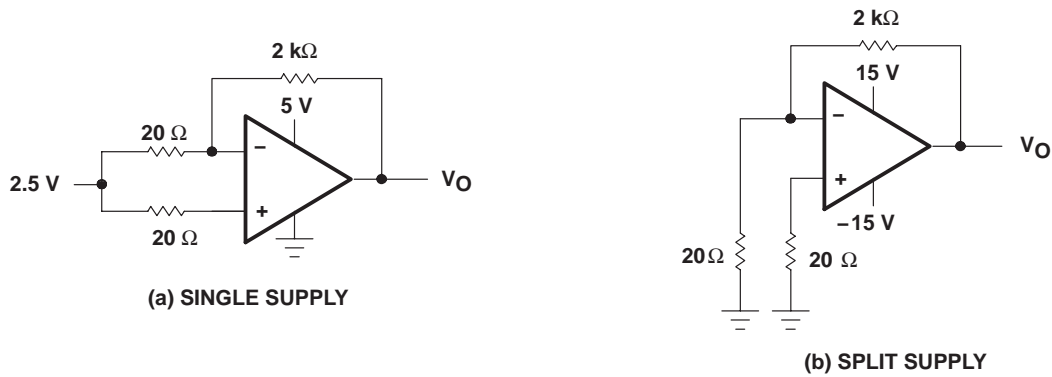
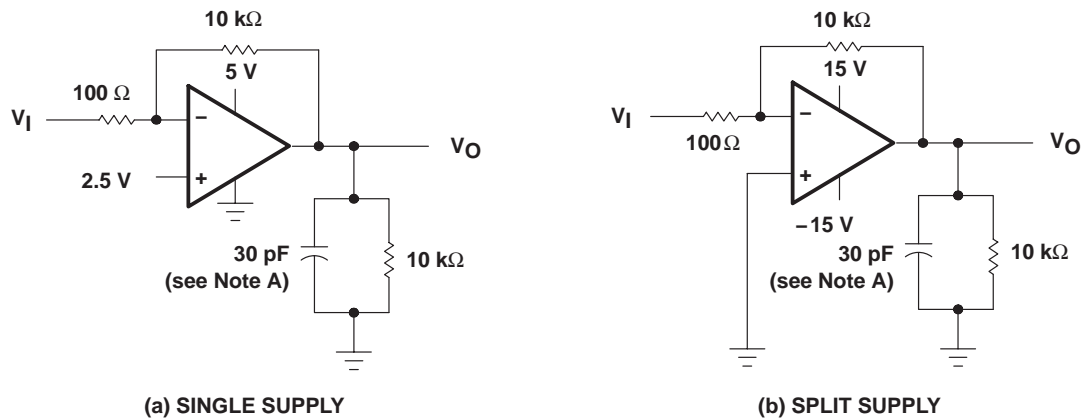

Figure 2. Noise-Voltage Test Circuit



NOTE A: C_L includes fixture capacitance.

Figure 3. Unity-Gain Bandwidth and Phase-Margin Test Circuit

TLE202x, TLE202xA, TLE202xB, TLE202xY EXCALIBUR HIGH-SPEED LOW-POWER PRECISION OPERATIONAL AMPLIFIERS

SLOS191C – FEBRUARY 1997 – REVISED APRIL 2007

PARAMETER MEASUREMENT INFORMATION

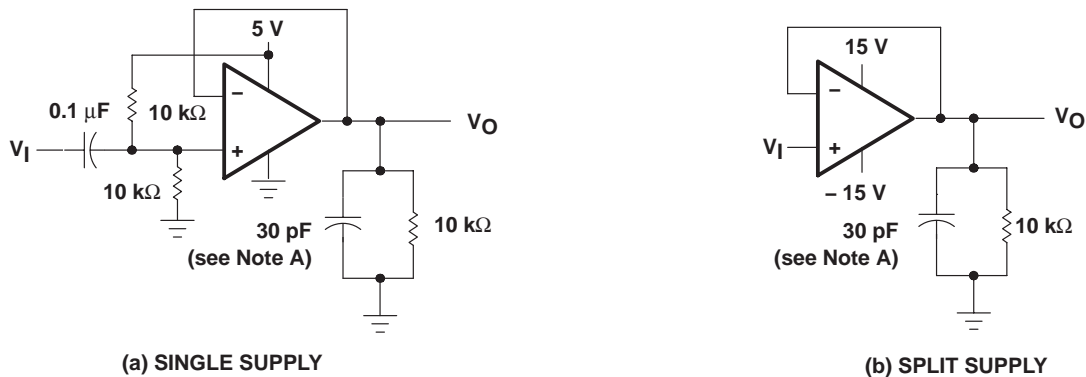

NOTE A: C_L includes fixture capacitance.

Figure 4. Small-Signal Pulse-Response Test Circuit

typical values

Typical values presented in this data sheet represent the median (50% point) of device parametric performance.

TLE202x, TLE202xA, TLE202xB, TLE202xY
EXCALIBUR HIGH-SPEED LOW-POWER PRECISION
OPERATIONAL AMPLIFIERS

SLOS191C – FEBRUARY 1997 – REVISED APRIL 2007

TYPICAL CHARACTERISTICS

Table of Graphs

			FIGURE
V_{IO}	Input offset voltage	Distribution	5, 6, 7
I_{IB}	Input bias current	vs Common-mode input voltage vs Free-air temperature	8, 9, 10 11, 12, 13
I_I	Input current	vs Differential input voltage	14
V_{OM}	Maximum peak output voltage	vs Output current vs Free-air temperature	15, 16, 17 18
V_{OH}	High-level output voltage	vs High-level output current vs Free-air temperature	19, 20 21
V_{OL}	Low-level output voltage	vs Low-level output current vs Free-air temperature	22 23
$V_{O(PP)}$	Maximum peak-to-peak output voltage	vs Frequency	24, 25
A_{VD}	Large-signal differential voltage amplification	vs Frequency vs Free-air temperature	26 27, 28, 29
I_{OS}	Short-circuit output current	vs Supply voltage vs Free-air temperature	30 – 33 34 – 37
I_{CC}	Supply current	vs Supply voltage vs Free-air temperature	38, 39, 40 41, 42, 43
CMRR	Common-mode rejection ratio	vs Frequency	44, 45, 46
SR	Slew rate	vs Free-air temperature	47, 48, 49
	Voltage-follower small-signal pulse response		50, 51
	Voltage-follower large-signal pulse response		52 – 57
$V_{N(PP)}$	Peak-to-peak equivalent input noise voltage	0.1 to 1 Hz 0.1 to 10 Hz	58 59
V_n	Equivalent input noise voltage	vs Frequency	60
B_1	Unity-gain bandwidth	vs Supply voltage vs Free-air temperature	61, 62 63, 64
ϕ_m	Phase margin	vs Supply voltage vs Load capacitance vs Free-air temperature	65, 66 67, 68 69, 70
	Phase shift	vs Frequency	26

TLE202x, TLE202xA, TLE202xB, TLE202xY
EXCALIBUR HIGH-SPEED LOW-POWER PRECISION
OPERATIONAL AMPLIFIERS

SLOS191C – FEBRUARY 1997 – REVISED APRIL 2007

TYPICAL CHARACTERISTICS

**DISTRIBUTION OF TLE2021
 INPUT OFFSET VOLTAGE**

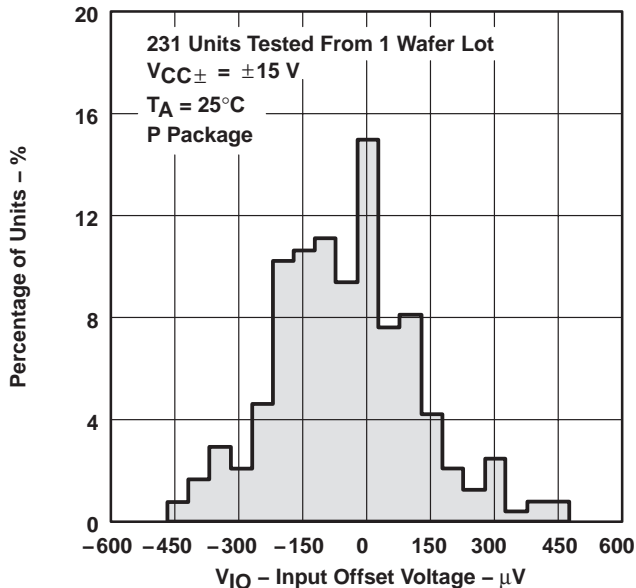

Figure 5

**DISTRIBUTION OF TLE2022
 INPUT OFFSET VOLTAGE**

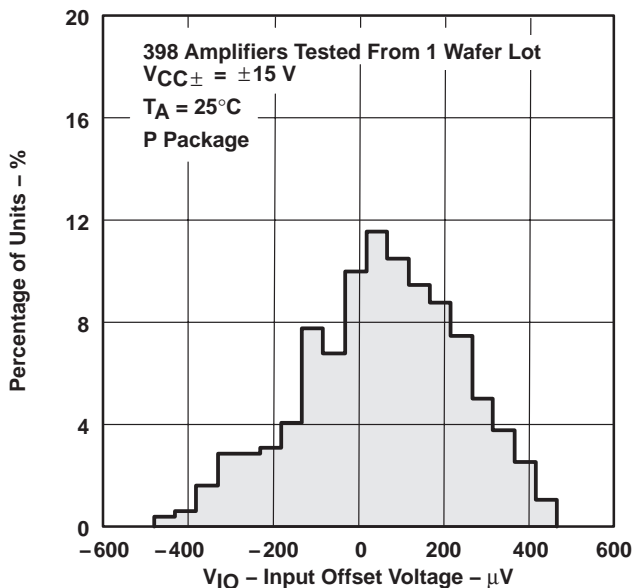

Figure 6

**DISTRIBUTION OF TLE2024
 INPUT OFFSET VOLTAGE**

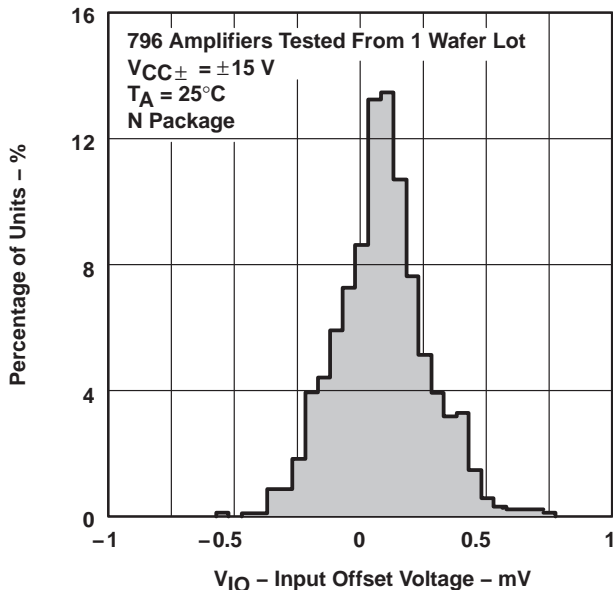

Figure 7

**TLE2021
 INPUT BIAS CURRENT
 vs
 COMMON-MODE INPUT VOLTAGE**

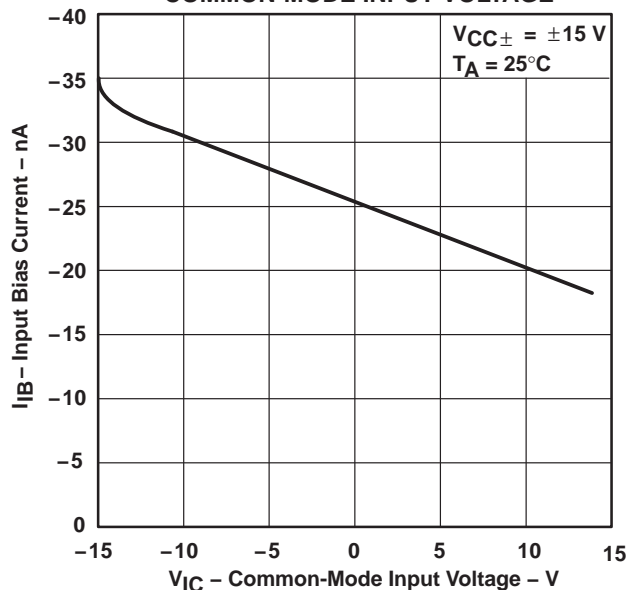
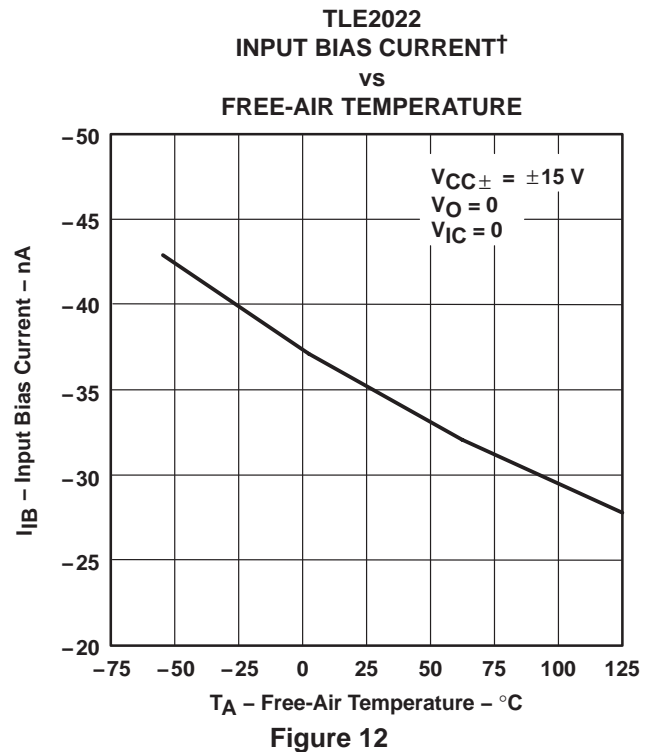
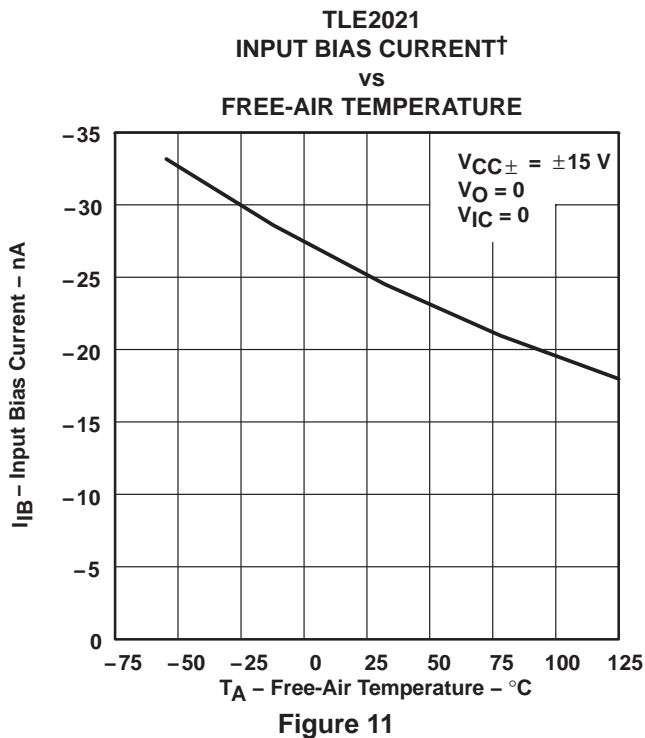
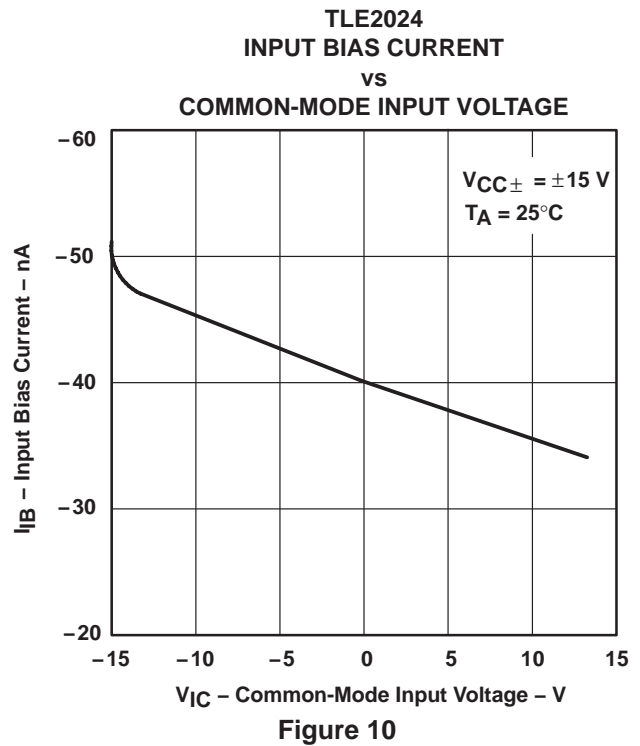
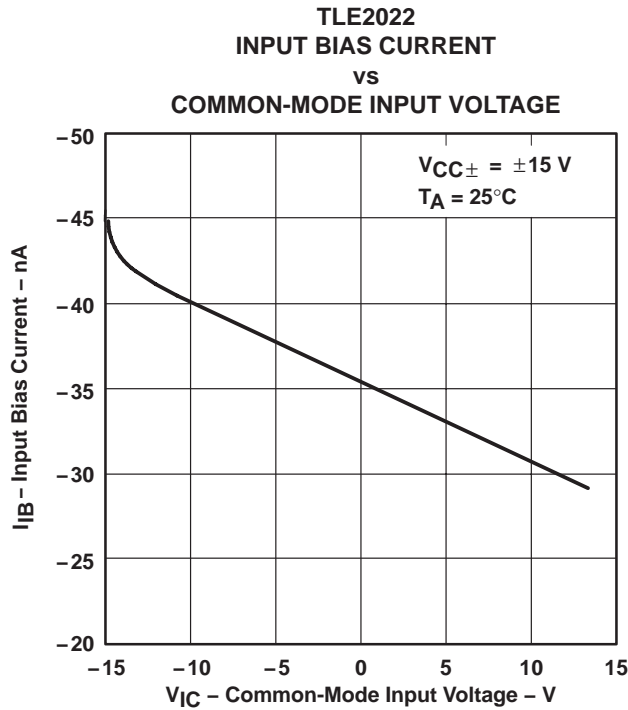

Figure 8

TLE202x, TLE202xA, TLE202xB, TLE202xY EXCALIBUR HIGH-SPEED LOW-POWER PRECISION OPERATIONAL AMPLIFIERS

SLOS191C – FEBRUARY 1997 – REVISED APRIL 2007

TYPICAL CHARACTERISTICS



† Data at high and low temperatures are applicable only within the rated operating free-air temperature ranges of the various devices.

TLE202x, TLE202xA, TLE202xB, TLE202xY EXCALIBUR HIGH-SPEED LOW-POWER PRECISION OPERATIONAL AMPLIFIERS

SLOS191C – FEBRUARY 1997 – REVISED APRIL 2007

TYPICAL CHARACTERISTICS

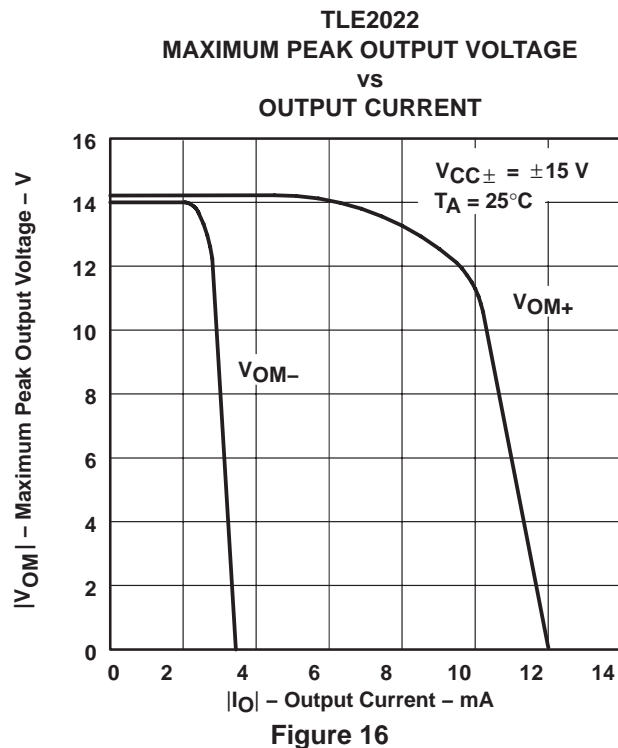
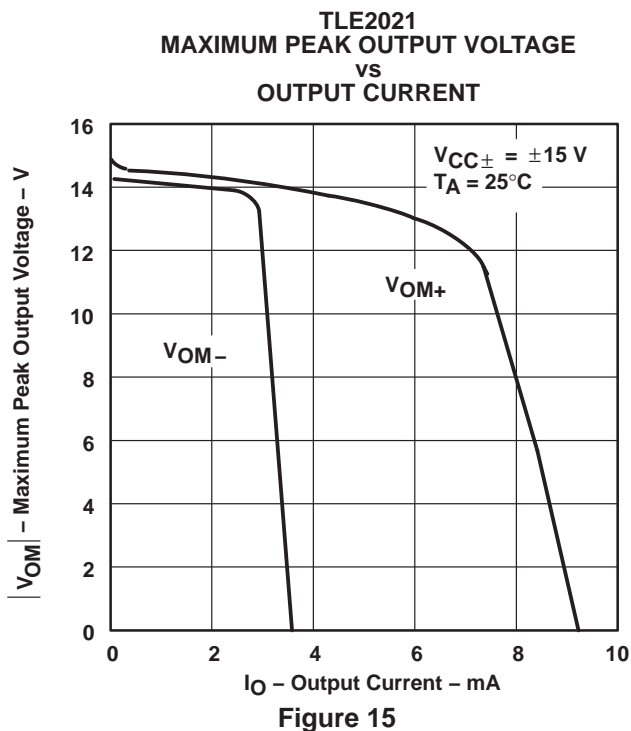
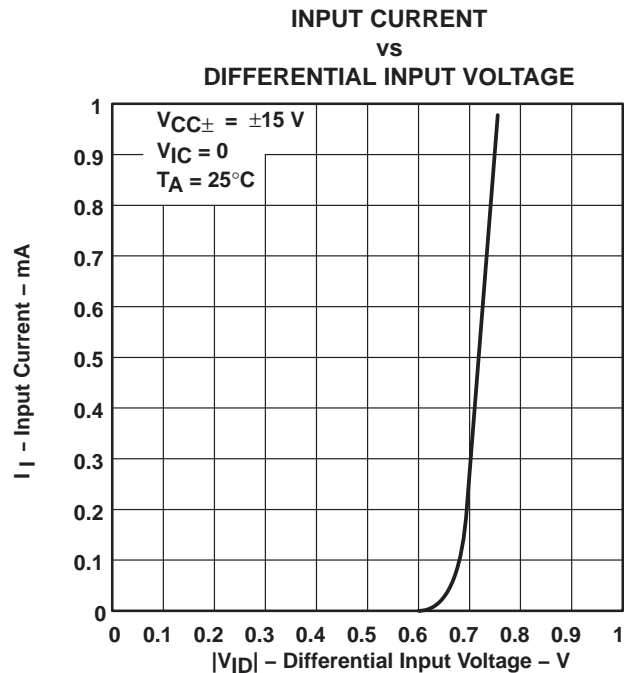
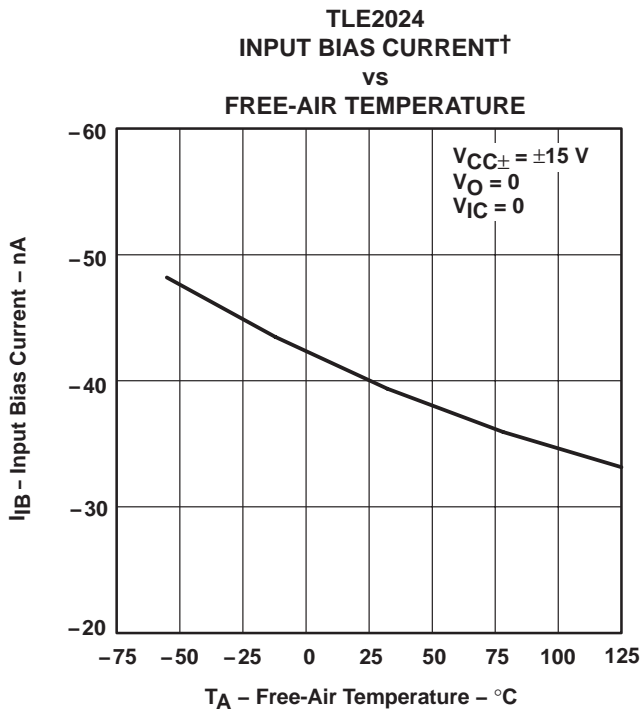

† Data at high and low temperatures are applicable only within the rated operating free-air temperature ranges of the various devices.

TLE202x, TLE202xA, TLE202xB, TLE202xY EXCALIBUR HIGH-SPEED LOW-POWER PRECISION OPERATIONAL AMPLIFIERS

SLOS191C – FEBRUARY 1997 – REVISED APRIL 2007

TYPICAL CHARACTERISTICS

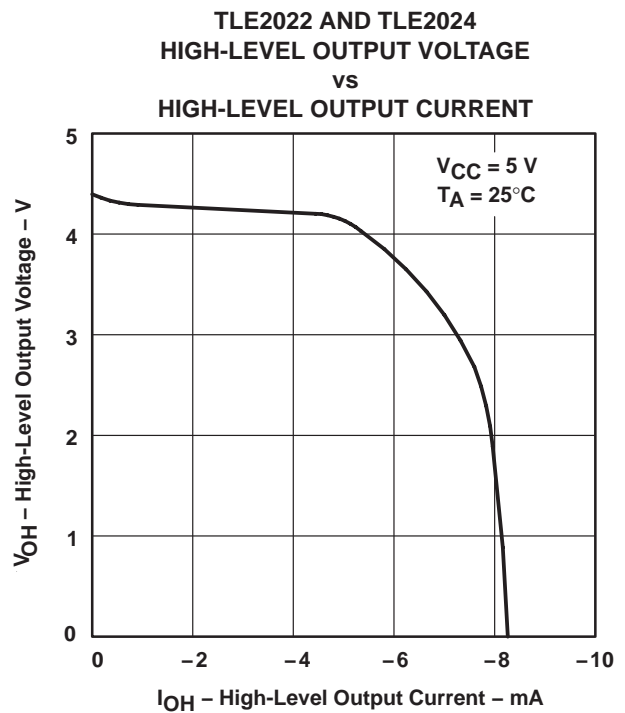
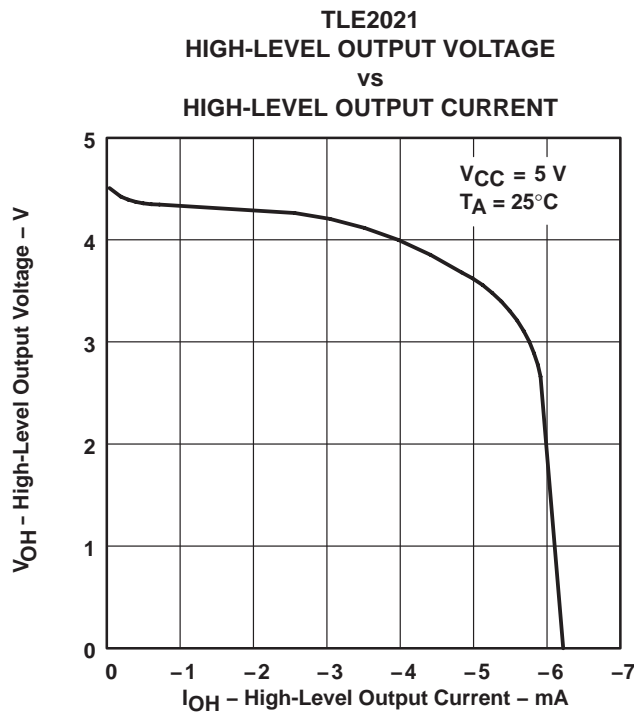
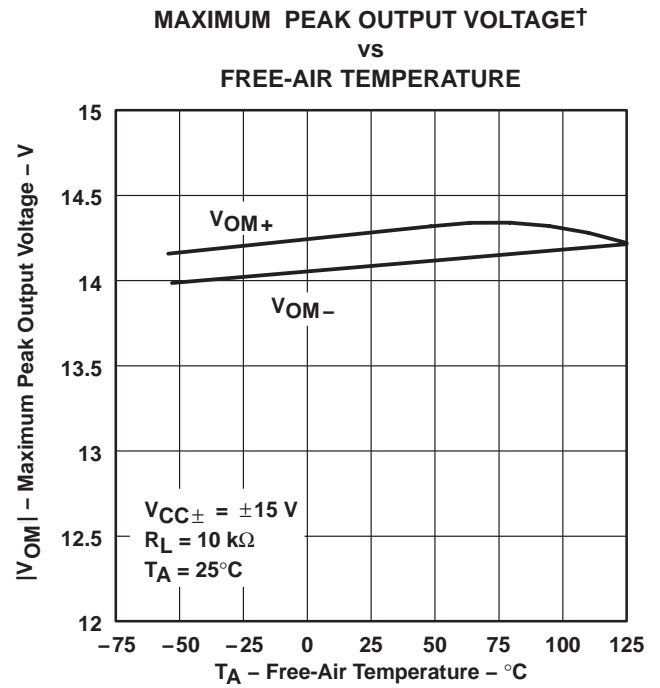
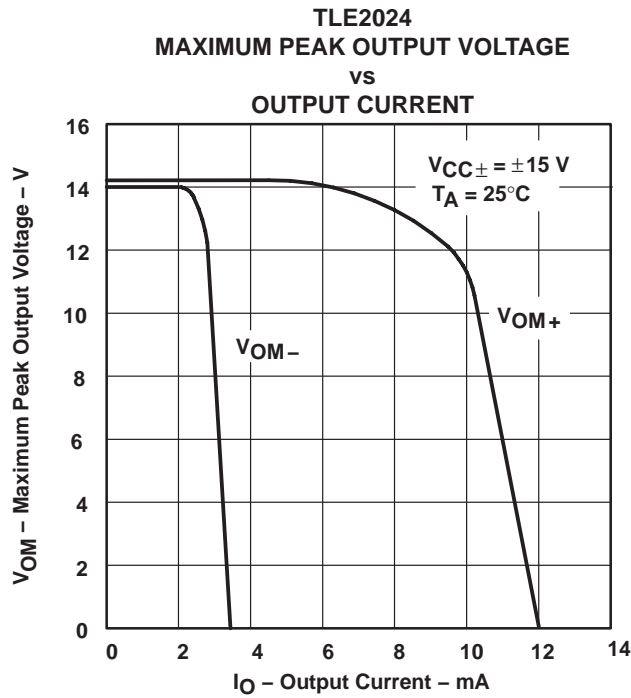

† Data at high and low temperatures are applicable only within the rated operating free-air temperature ranges of the various devices.

TLE202x, TLE202xA, TLE202xB, TLE202xY EXCALIBUR HIGH-SPEED LOW-POWER PRECISION OPERATIONAL AMPLIFIERS

SLOS191C – FEBRUARY 1997 – REVISED APRIL 2007

TYPICAL CHARACTERISTICS

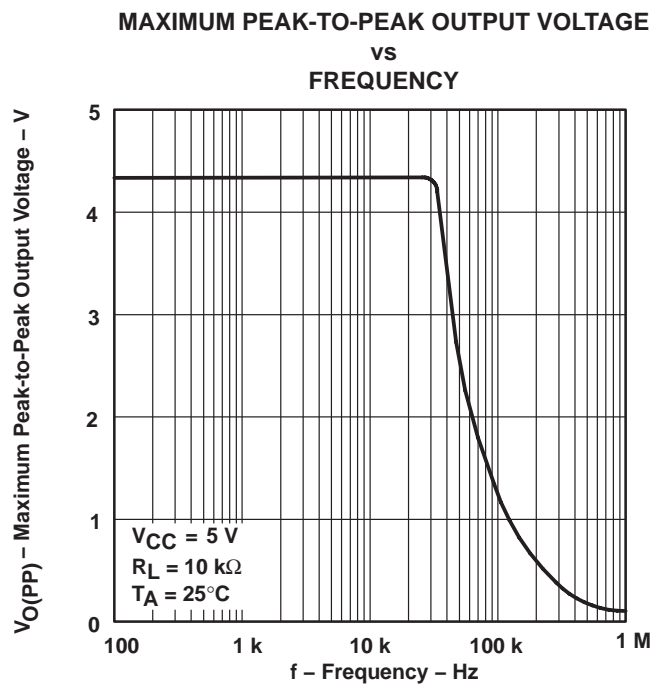
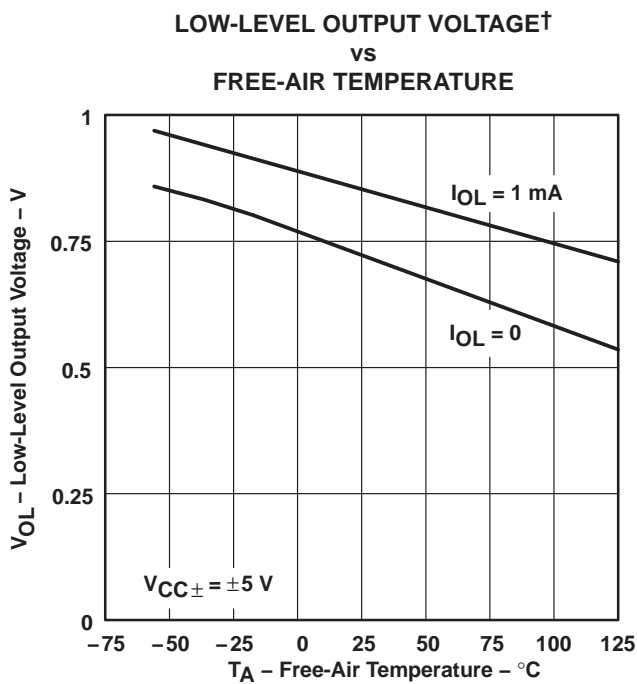
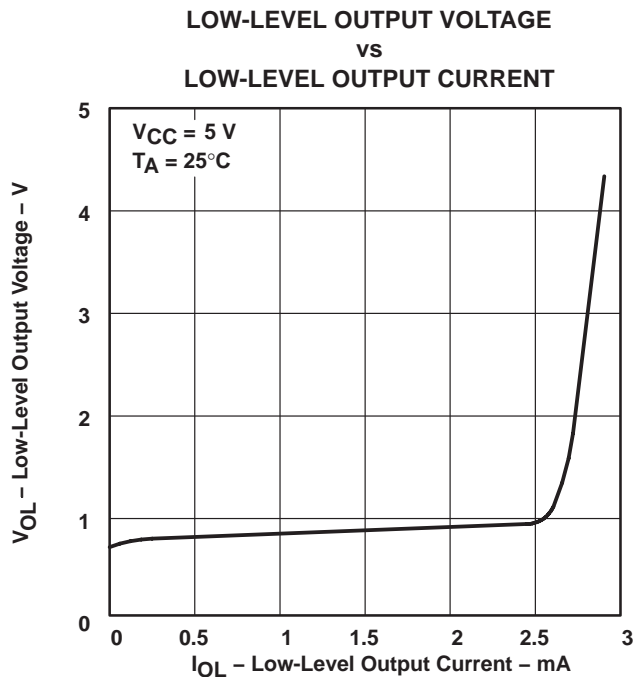
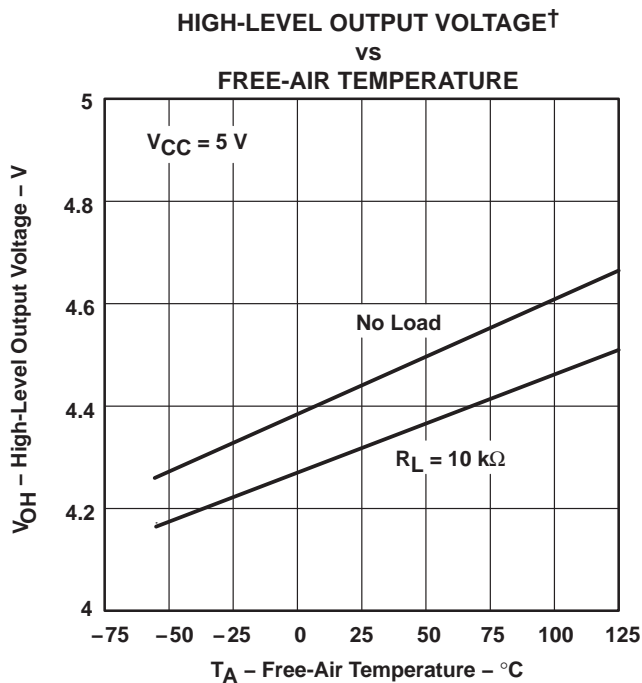

† Data at high and low temperatures are applicable only within the rated operating free-air temperature ranges of the various devices.

TLE202x, TLE202xA, TLE202xB, TLE202xY EXCALIBUR HIGH-SPEED LOW-POWER PRECISION OPERATIONAL AMPLIFIERS

SLOS191C – FEBRUARY 1997 – REVISED APRIL 2007

TYPICAL CHARACTERISTICS

MAXIMUM PEAK-TO-PEAK OUTPUT VOLTAGE vs FREQUENCY

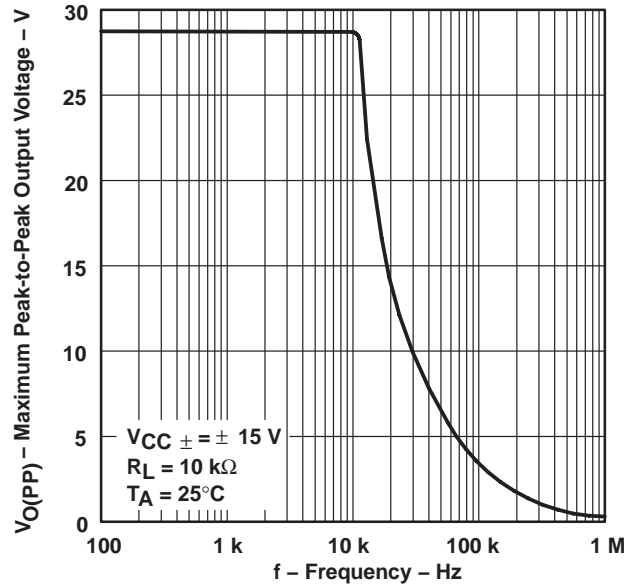

Figure 25

LARGE-SIGNAL DIFFERENTIAL VOLTAGE AMPLIFICATION AND PHASE SHIFT vs FREQUENCY

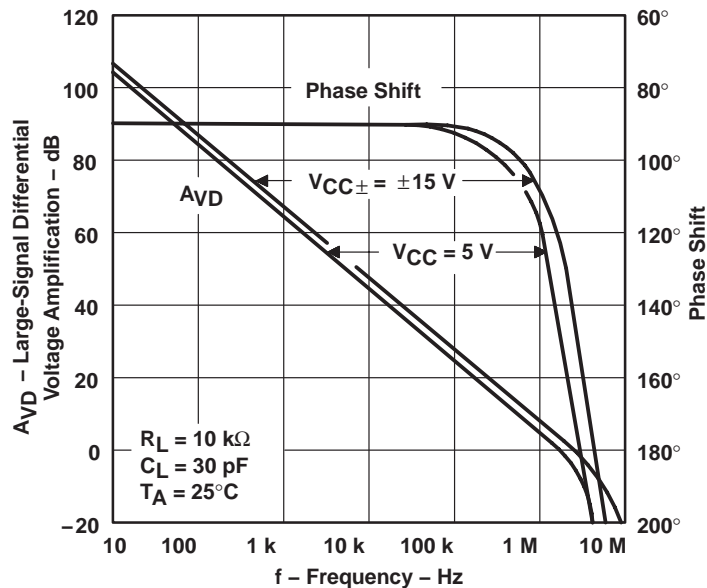

Figure 26

TLE202x, TLE202xA, TLE202xB, TLE202xY EXCALIBUR HIGH-SPEED LOW-POWER PRECISION OPERATIONAL AMPLIFIERS

SLOS191C – FEBRUARY 1997 – REVISED APRIL 2007

TYPICAL CHARACTERISTICS

TLE2021
LARGE-SCALE DIFFERENTIAL VOLTAGE
AMPLIFICATION†
vs
FREE-AIR TEMPERATURE

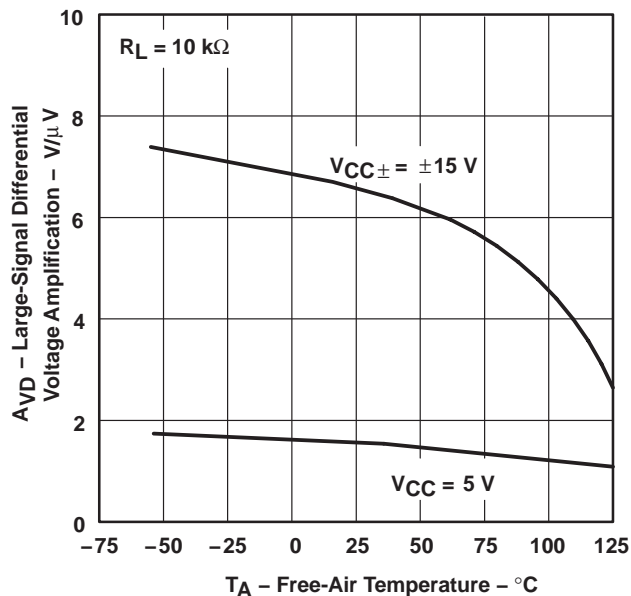

Figure 27

TLE2022
LARGE-SIGNAL DIFFERENTIAL VOLTAGE
AMPLIFICATION†
vs
FREE-AIR TEMPERATURE

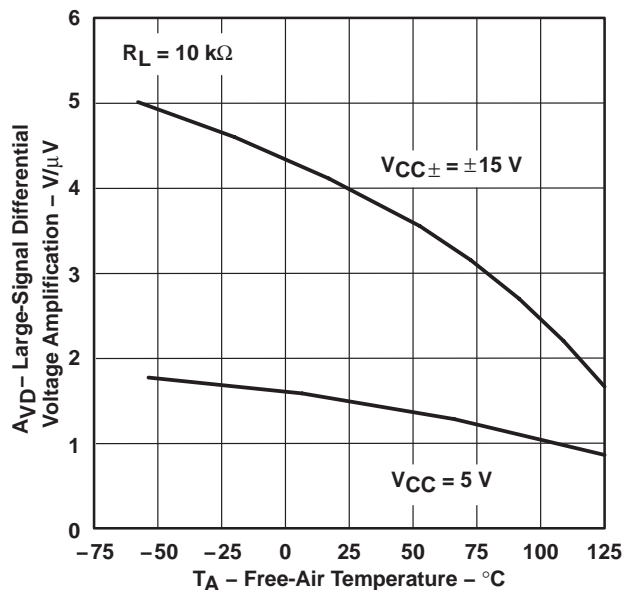

Figure 28

TLE2024
LARGE-SCALE DIFFERENTIAL VOLTAGE
AMPLIFICATION†
vs
FREE-AIR TEMPERATURE

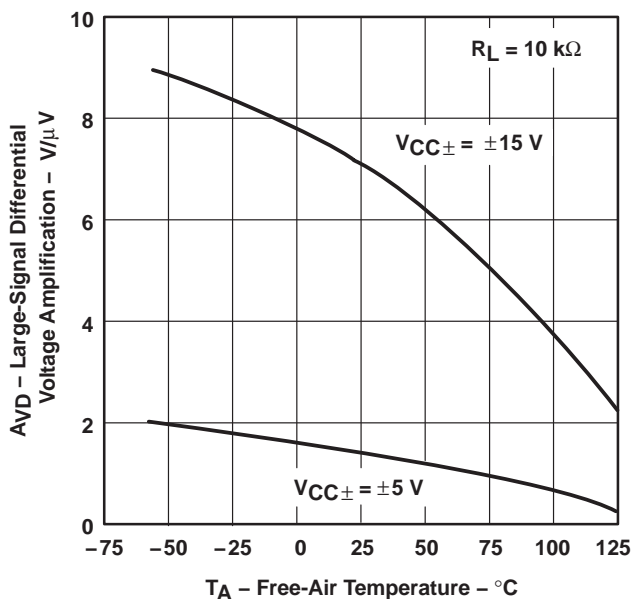

Figure 29

TLE2021
SHORT-CIRCUIT OUTPUT CURRENT
vs
SUPPLY VOLTAGE

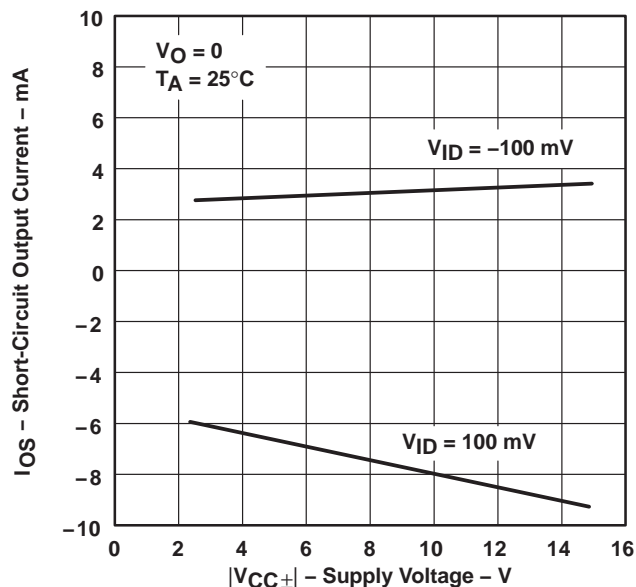

Figure 30

† Data at high and low temperatures are applicable only within the rated operating free-air temperature ranges of the various devices.

TLE202x, TLE202xA, TLE202xB, TLE202xY EXCALIBUR HIGH-SPEED LOW-POWER PRECISION OPERATIONAL AMPLIFIERS

SLOS191C – FEBRUARY 1997 – REVISED APRIL 2007

TYPICAL CHARACTERISTICS

TLE2022 AND TLE2024
SHORT-CIRCUIT OUTPUT CURRENT
vs
SUPPLY VOLTAGE

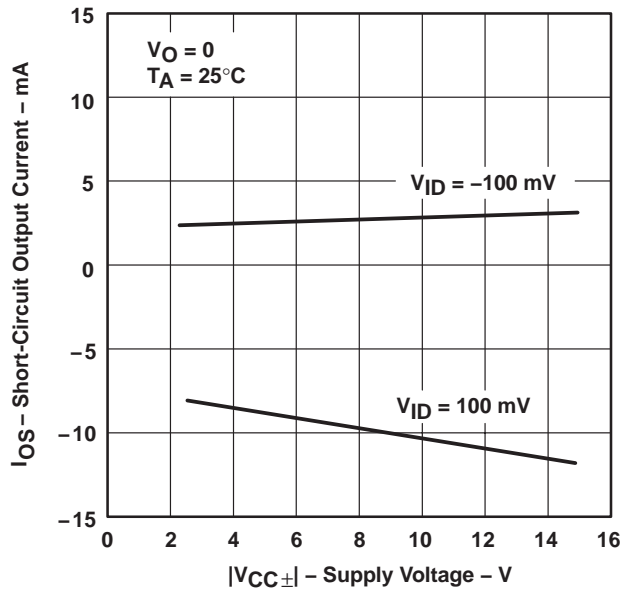

Figure 31

TLE2021
SHORT-CIRCUIT OUTPUT CURRENT
vs
SUPPLY VOLTAGE

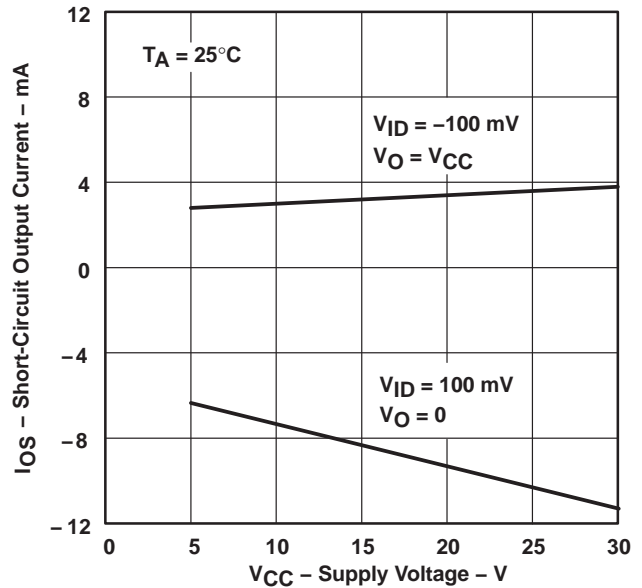

Figure 32

TLE2022 AND TLE2024
SHORT-CIRCUIT OUTPUT CURRENT
vs
SUPPLY VOLTAGE

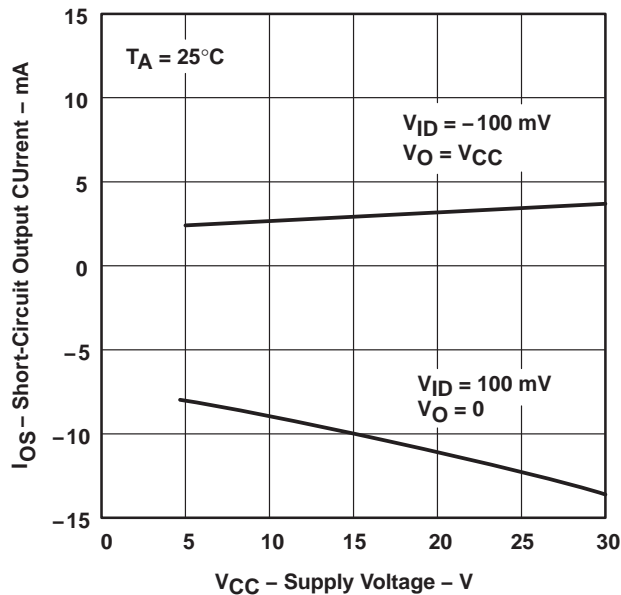

Figure 33

TLE2021
SHORT-CIRCUIT OUTPUT CURRENT†
vs
FREE-AIR TEMPERATURE

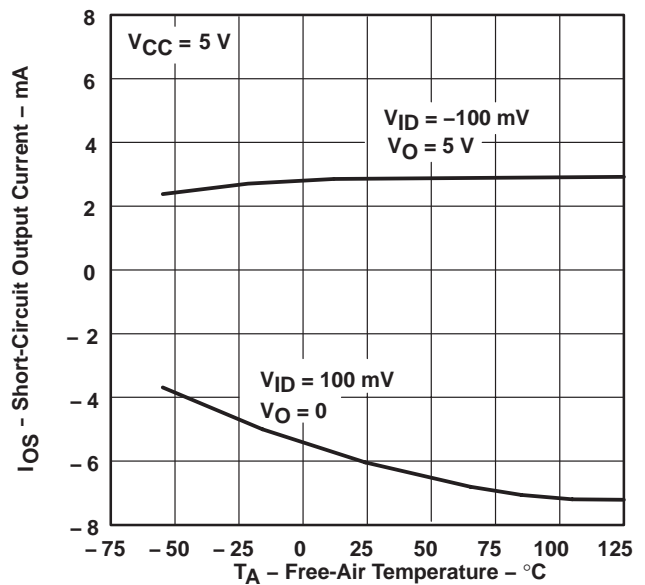

Figure 34

† Data at high and low temperatures are applicable only within the rated operating free-air temperature ranges of the various devices.

TLE202x, TLE202xA, TLE202xB, TLE202xY EXCALIBUR HIGH-SPEED LOW-POWER PRECISION OPERATIONAL AMPLIFIERS

SLOS191C – FEBRUARY 1997 – REVISED APRIL 2007

TYPICAL CHARACTERISTICS

TLE2022 AND TLE2024
SHORT-CIRCUIT OUTPUT CURRENT†
vs
FREE-AIR TEMPERATURE

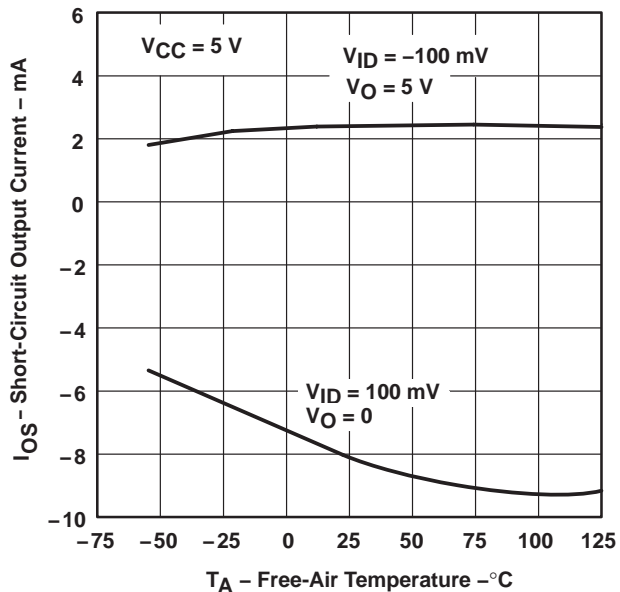

Figure 35

TLE2021
SHORT-CIRCUIT OUTPUT CURRENT†
vs
FREE-AIR TEMPERATURE

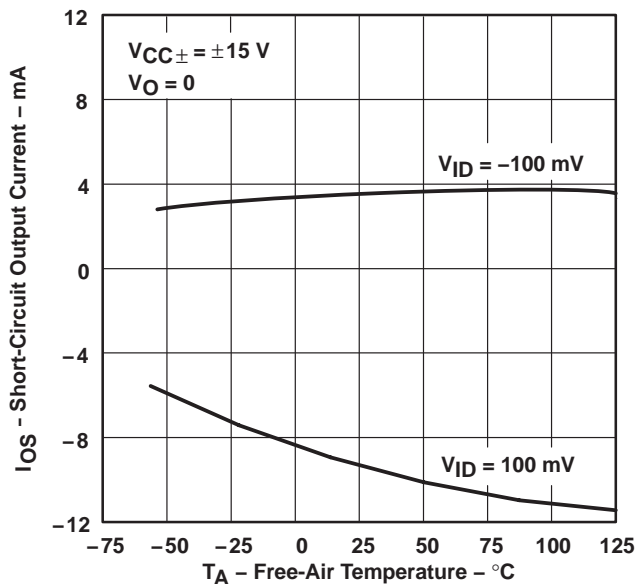

Figure 36

TLE2022 AND TLE2024
SHORT-CIRCUIT OUTPUT CURRENT†
vs
FREE-AIR TEMPERATURE

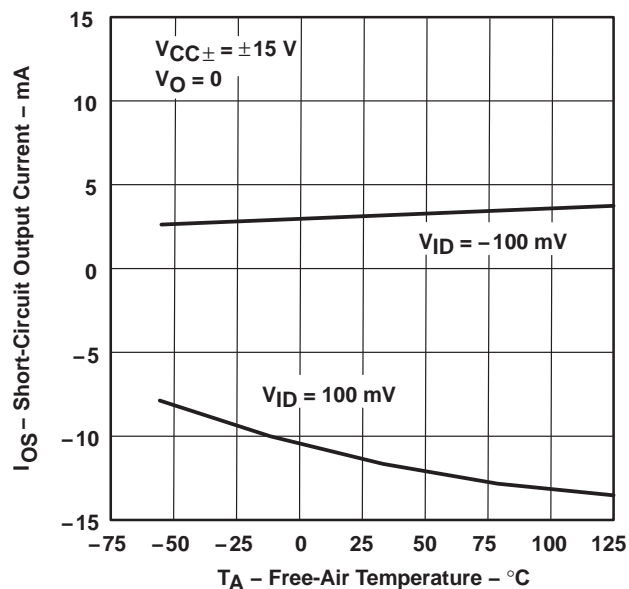

Figure 37

TLE2021
SUPPLY CURRENT
vs
SUPPLY VOLTAGE

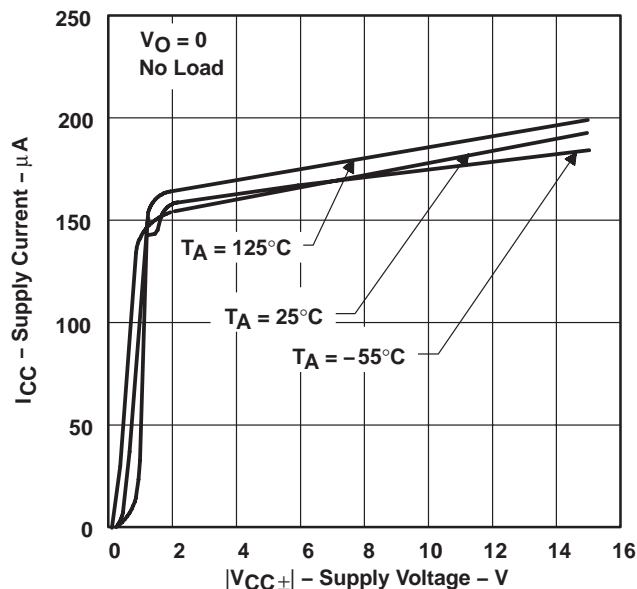

Figure 38

† Data at high and low temperatures are applicable only within the rated operating free-air temperature ranges of the various devices.

TLE202x, TLE202xA, TLE202xB, TLE202xY EXCALIBUR HIGH-SPEED LOW-POWER PRECISION OPERATIONAL AMPLIFIERS

SLOS191C – FEBRUARY 1997 – REVISED APRIL 2007

TYPICAL CHARACTERISTICS

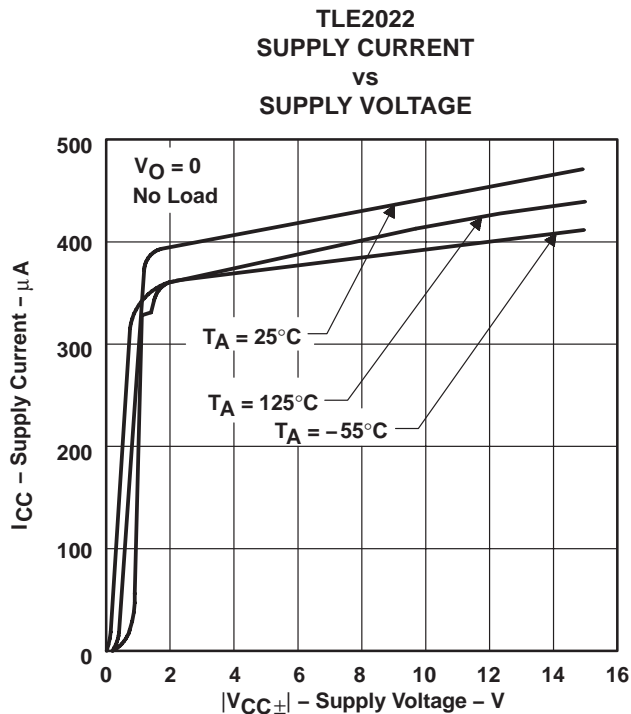

Figure 39

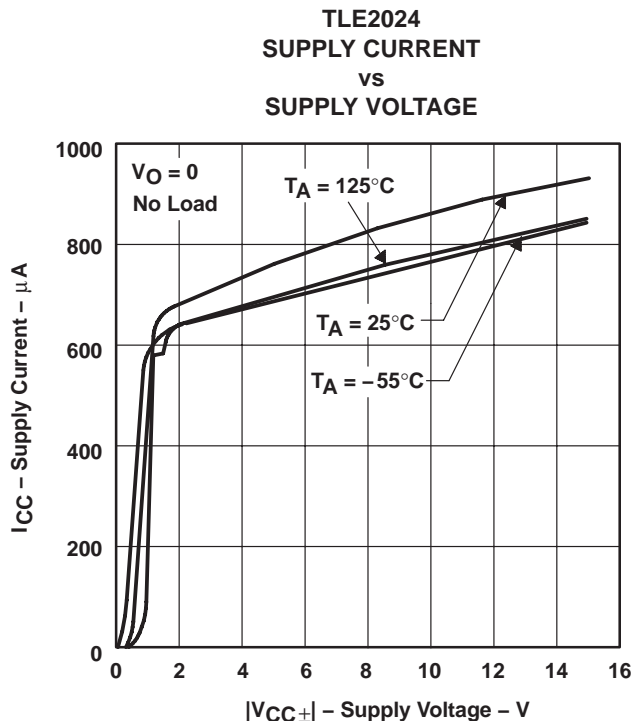

Figure 40

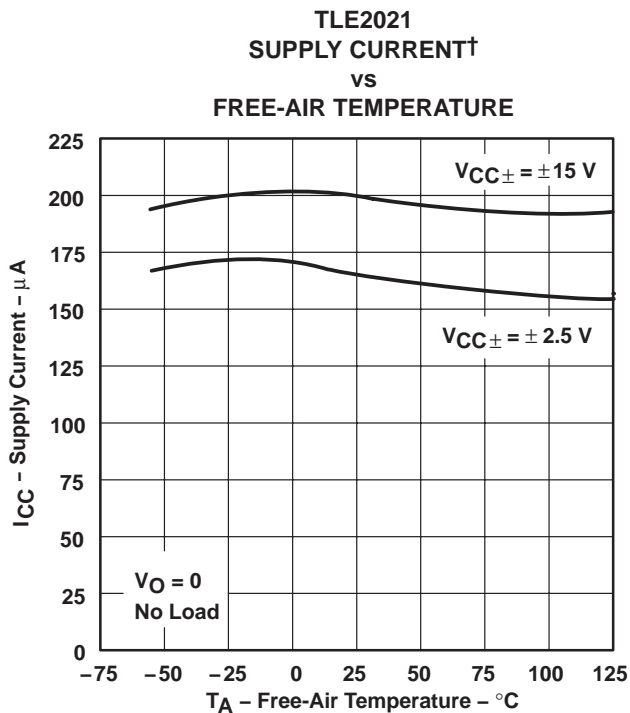

Figure 41

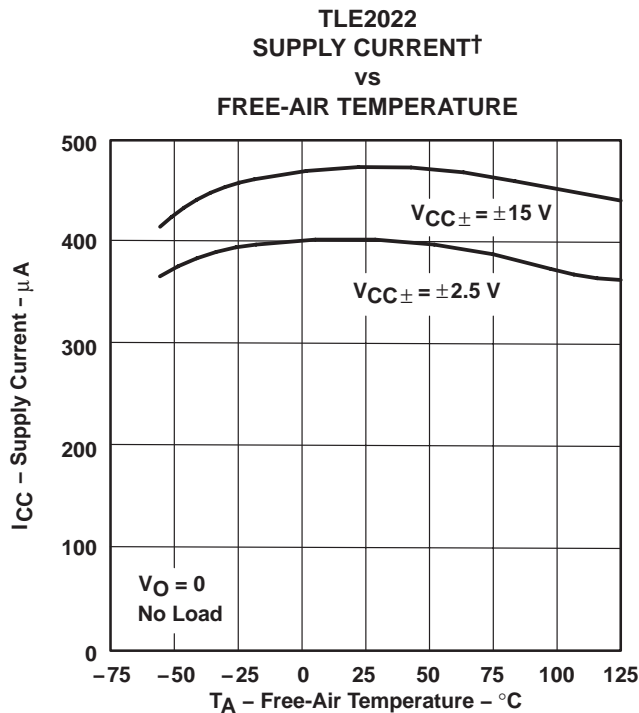

Figure 42

† Data at high and low temperatures are applicable only within the rated operating free-air temperature ranges of the various devices.

TLE202x, TLE202xA, TLE202xB, TLE202xY EXCALIBUR HIGH-SPEED LOW-POWER PRECISION OPERATIONAL AMPLIFIERS

SLOS191C – FEBRUARY 1997 – REVISED APRIL 2007

TYPICAL CHARACTERISTICS

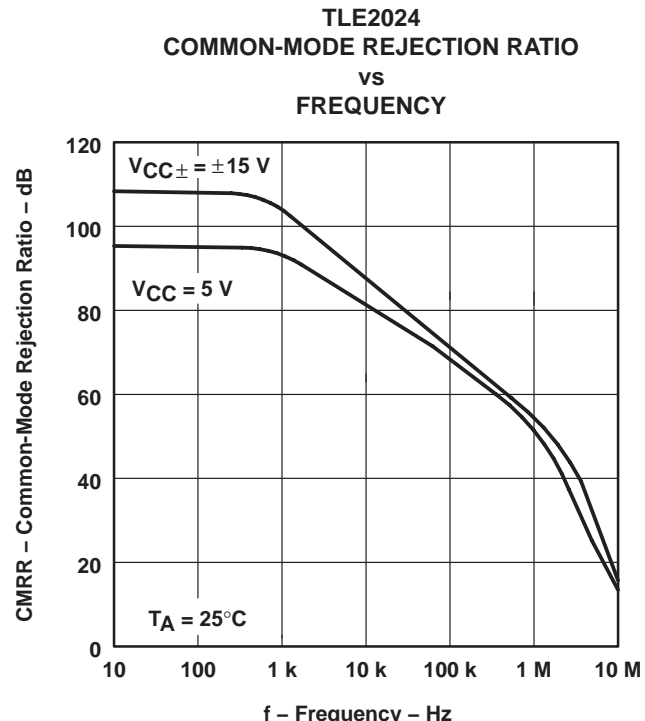
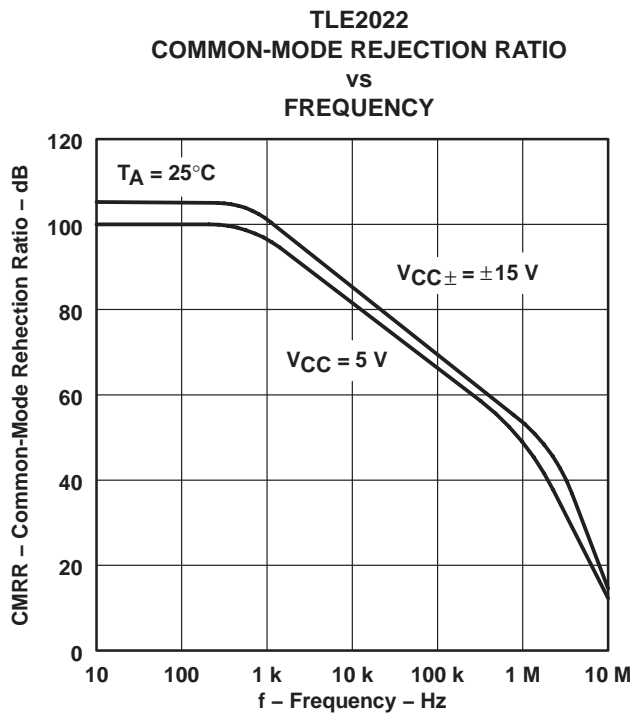
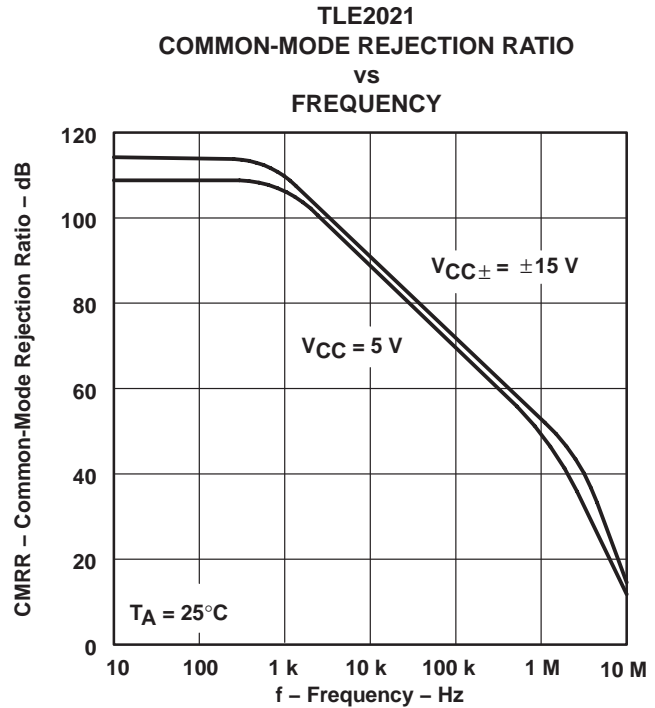
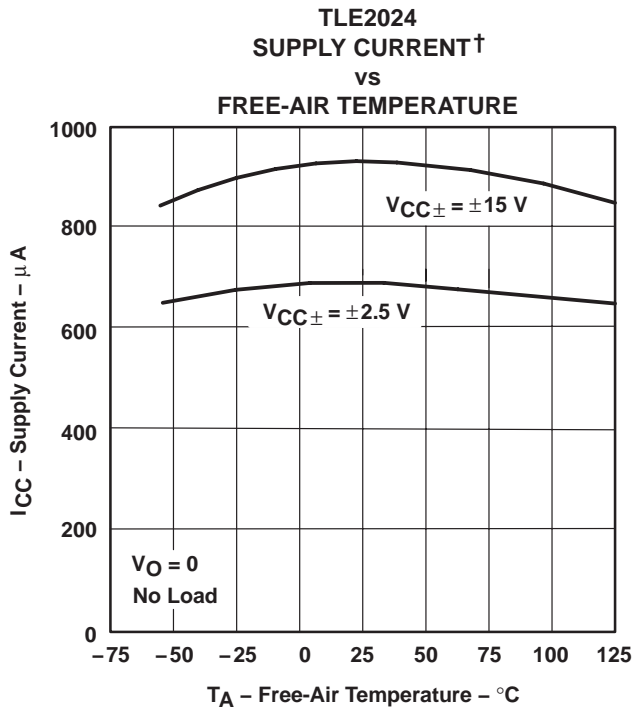

† Data at high and low temperatures are applicable only within the rated operating free-air temperature ranges of the various devices.

TLE202x, TLE202xA, TLE202xB, TLE202xY EXCALIBUR HIGH-SPEED LOW-POWER PRECISION OPERATIONAL AMPLIFIERS

SLOS191C – FEBRUARY 1997 – REVISED APRIL 2007

TYPICAL CHARACTERISTICS

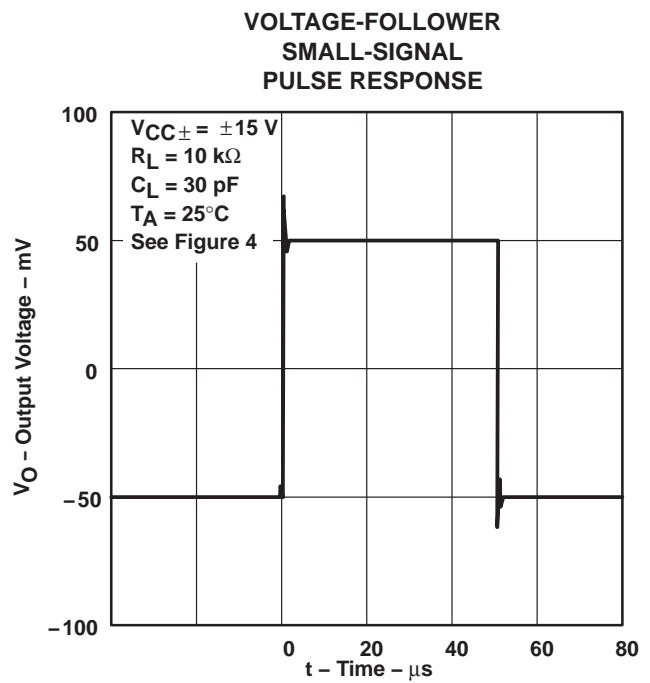
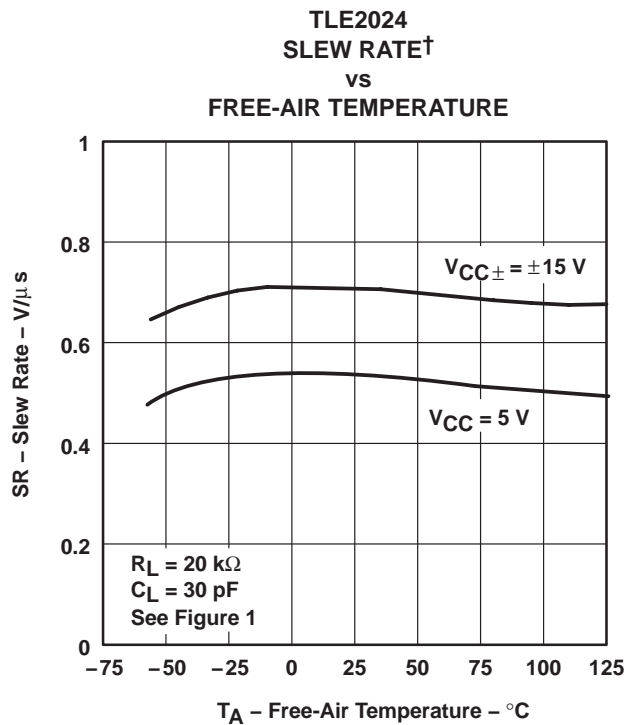
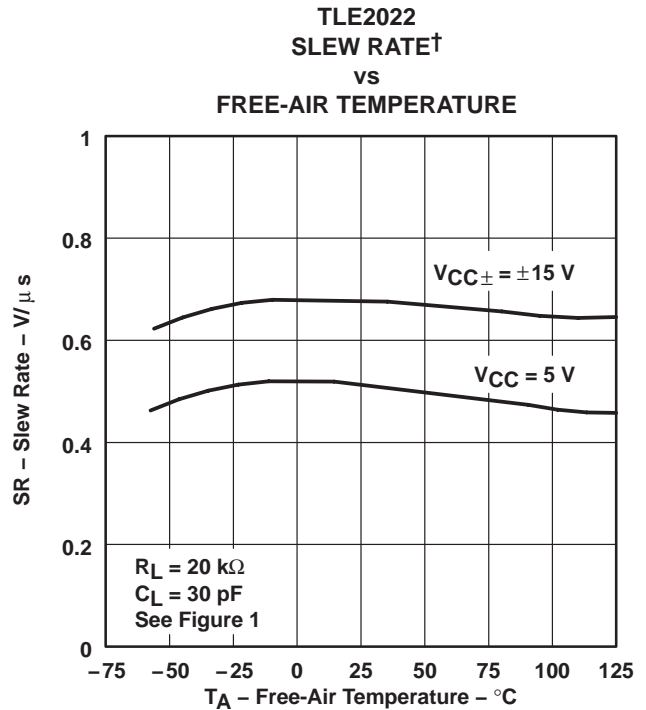
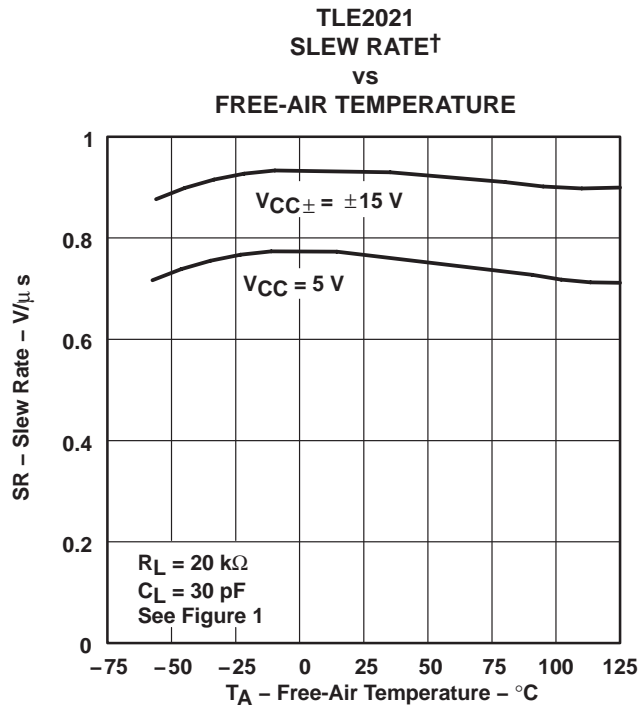

† Data at high and low temperatures are applicable only within the rated operating free-air temperature ranges of the various devices.

TLE202x, TLE202xA, TLE202xB, TLE202xY EXCALIBUR HIGH-SPEED LOW-POWER PRECISION OPERATIONAL AMPLIFIERS

SLOS191C – FEBRUARY 1997 – REVISED APRIL 2007

TYPICAL CHARACTERISTICS

**VOLTAGE-FOLLOWER
SMALL-SIGNAL
PULSE RESPONSE**

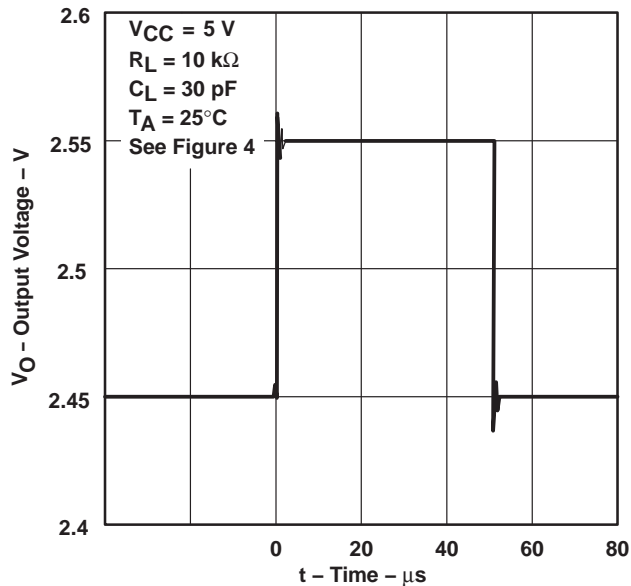

Figure 51

**TLE2021
VOLTAGE-FOLLOWER LARGE-SIGNAL
PULSE RESPONSE**

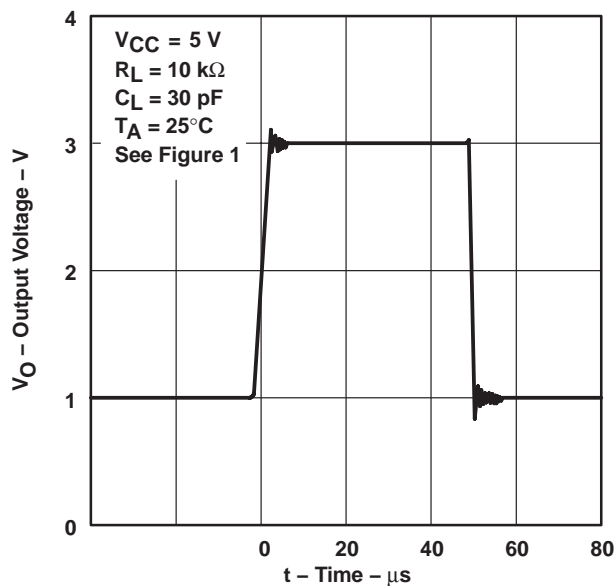

Figure 52

**TLE2022
VOLTAGE-FOLLOWER LARGE-SIGNAL
PULSE RESPONSE**

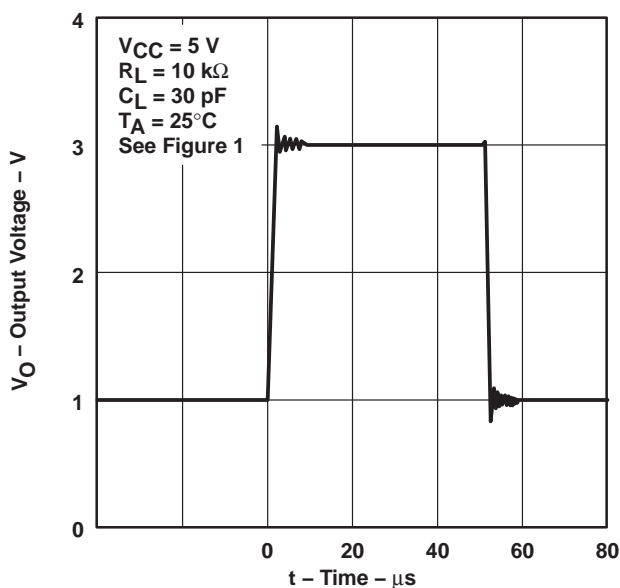

Figure 53

**TLE2024
VOLTAGE-FOLLOWER LARGE-SCALE
PULSE RESPONSE**

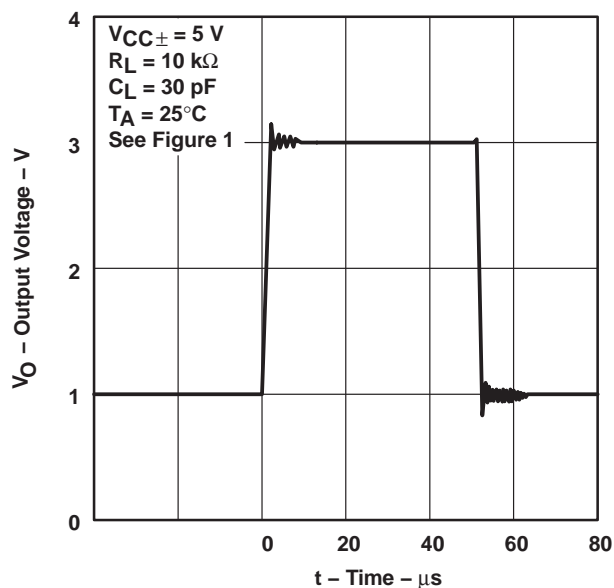

Figure 54

TLE202x, TLE202xA, TLE202xB, TLE202xY EXCALIBUR HIGH-SPEED LOW-POWER PRECISION OPERATIONAL AMPLIFIERS

SLOS191C – FEBRUARY 1997 – REVISED APRIL 2007

TYPICAL CHARACTERISTICS

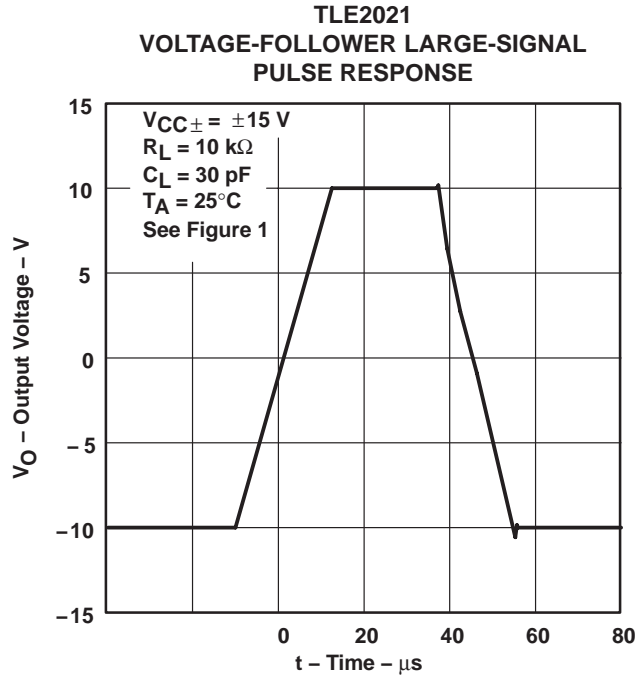

Figure 55

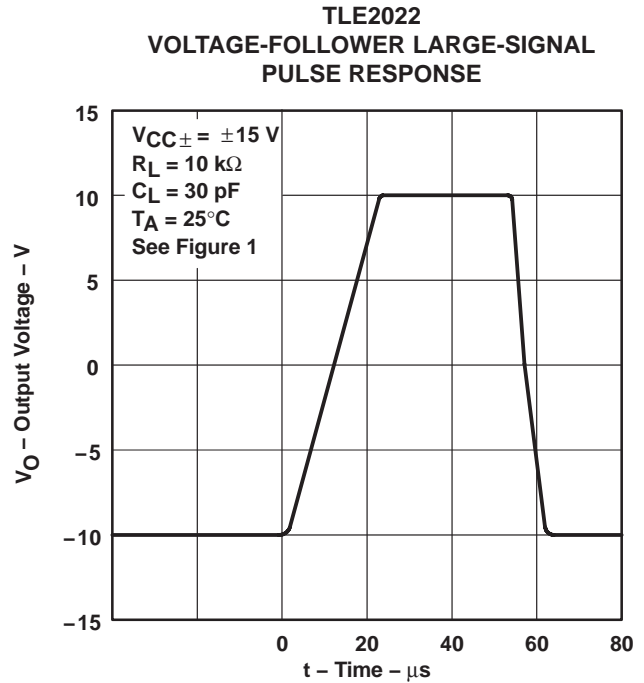

Figure 56

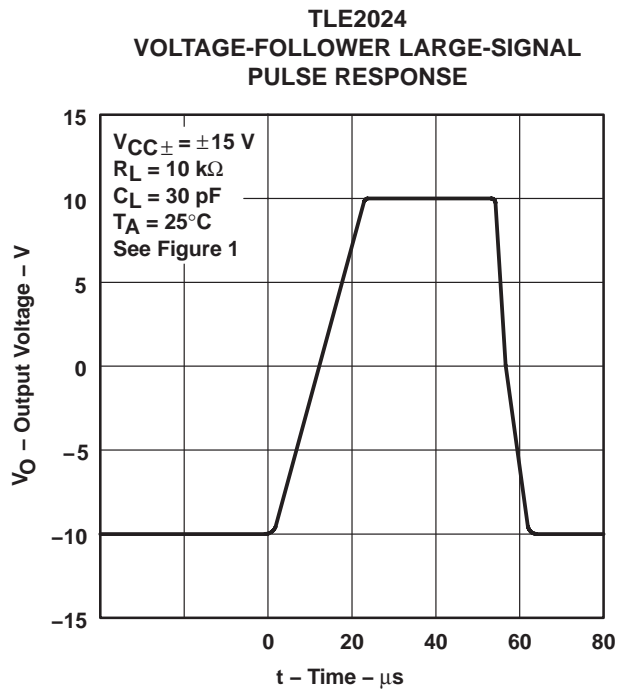

Figure 57

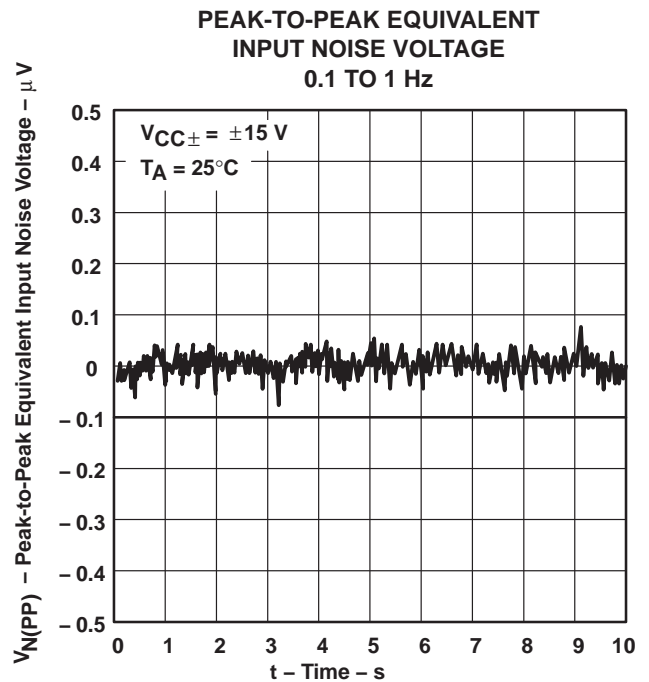

Figure 58

TLE202x, TLE202xA, TLE202xB, TLE202xY
EXCALIBUR HIGH-SPEED LOW-POWER PRECISION
OPERATIONAL AMPLIFIERS

SLOS191C – FEBRUARY 1997 – REVISED APRIL 2007

TYPICAL CHARACTERISTICS

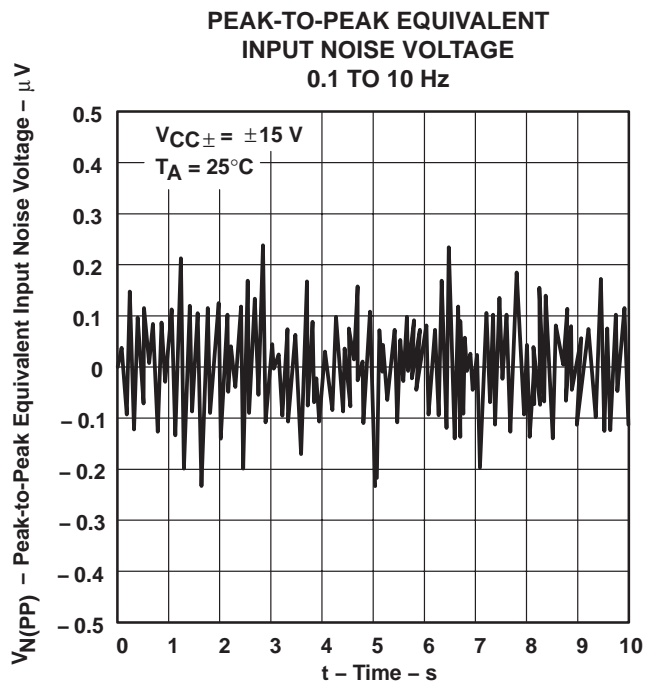

Figure 59

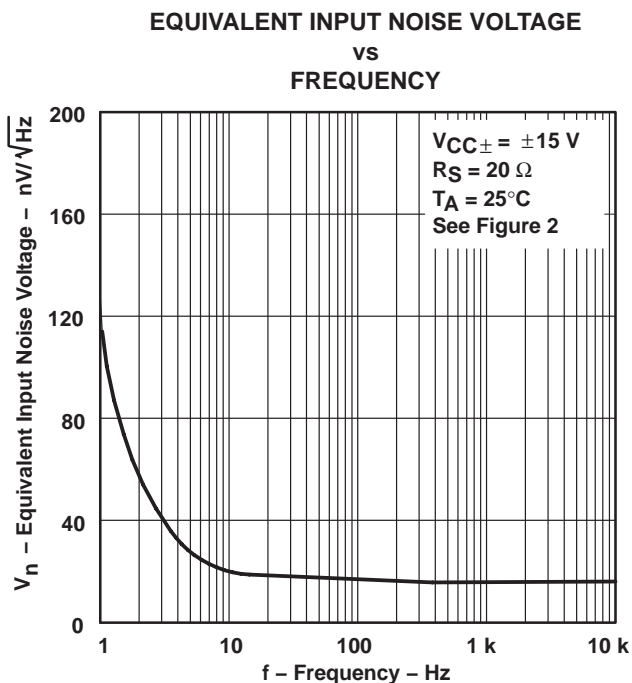

Figure 60

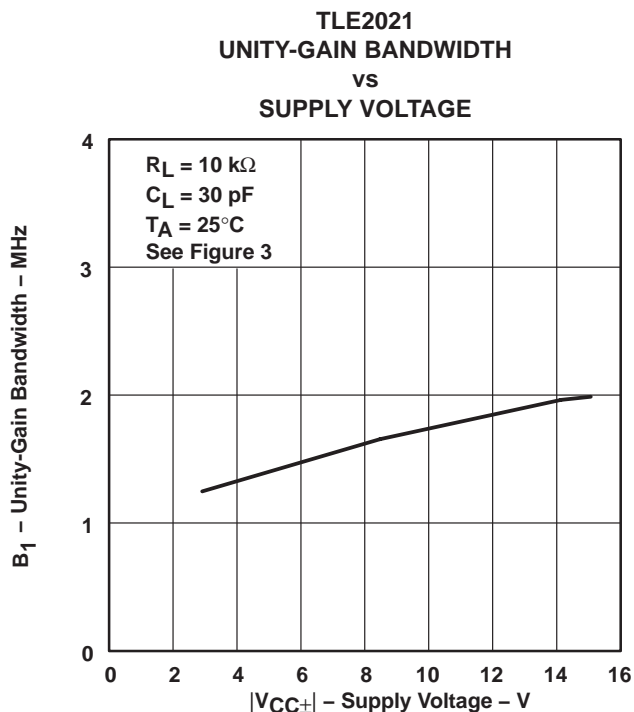

Figure 61

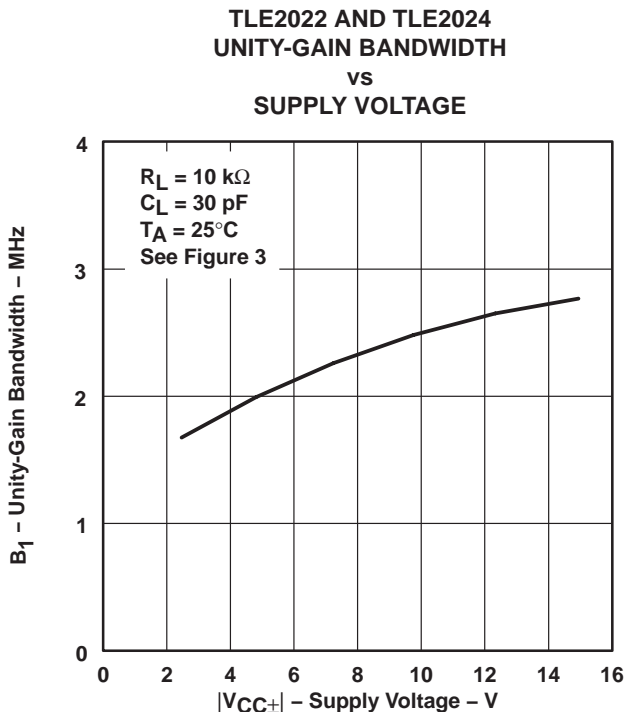

Figure 62



TLE202x, TLE202xA, TLE202xB, TLE202xY EXCALIBUR HIGH-SPEED LOW-POWER PRECISION OPERATIONAL AMPLIFIERS

SLOS191C – FEBRUARY 1997 – REVISED APRIL 2007

TYPICAL CHARACTERISTICS

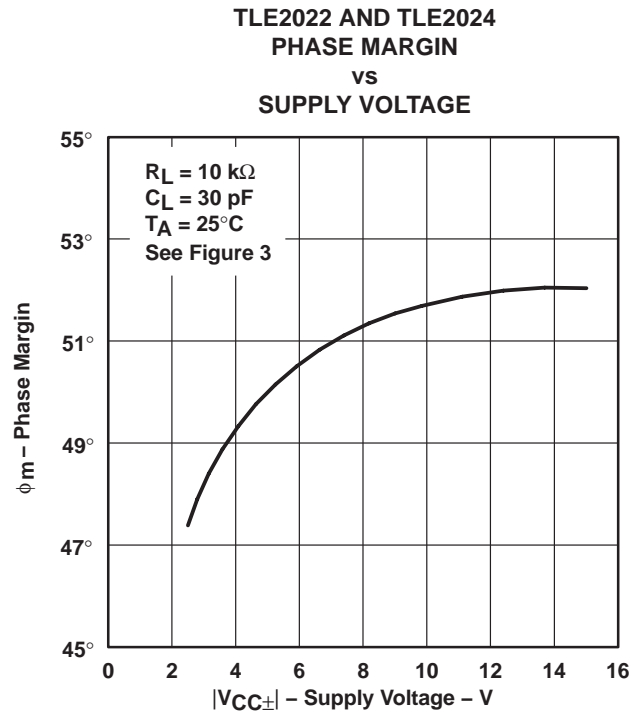
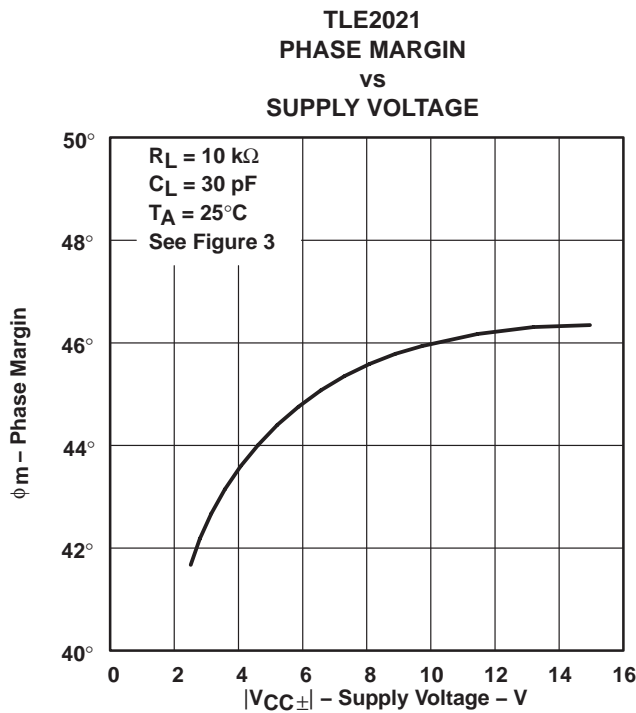
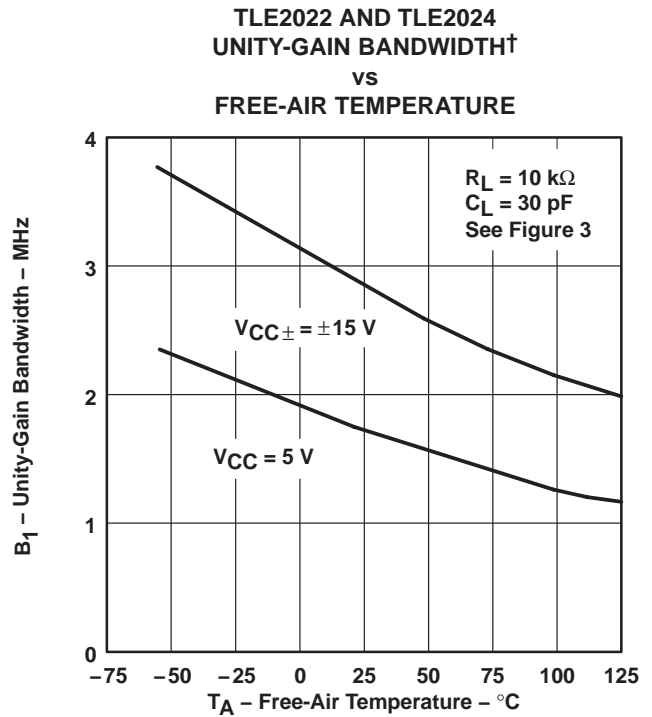
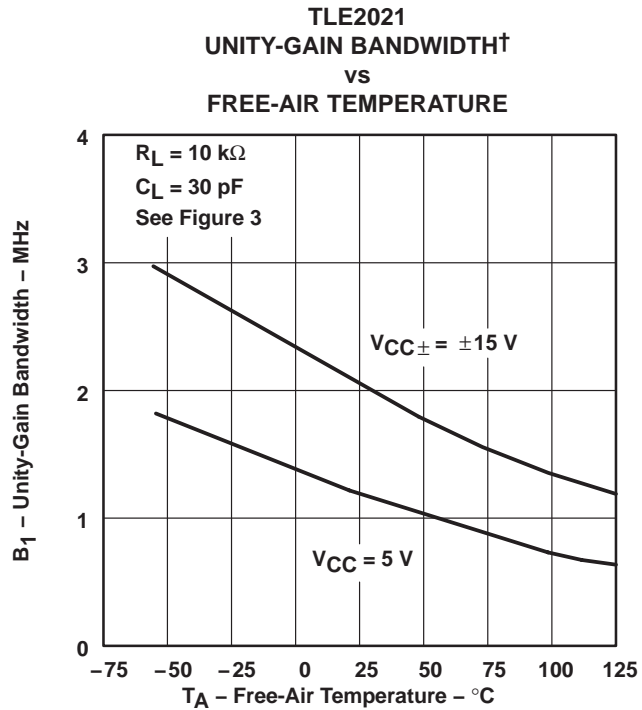

† Data at high and low temperatures are applicable only within the rated operating free-air temperature ranges of the various devices.

TLE202x, TLE202xA, TLE202xB, TLE202xY EXCALIBUR HIGH-SPEED LOW-POWER PRECISION OPERATIONAL AMPLIFIERS

SLOS191C – FEBRUARY 1997 – REVISED APRIL 2007

TYPICAL CHARACTERISTICS

**TLE2021
PHASE MARGIN
VS
LOAD CAPACITANCE**

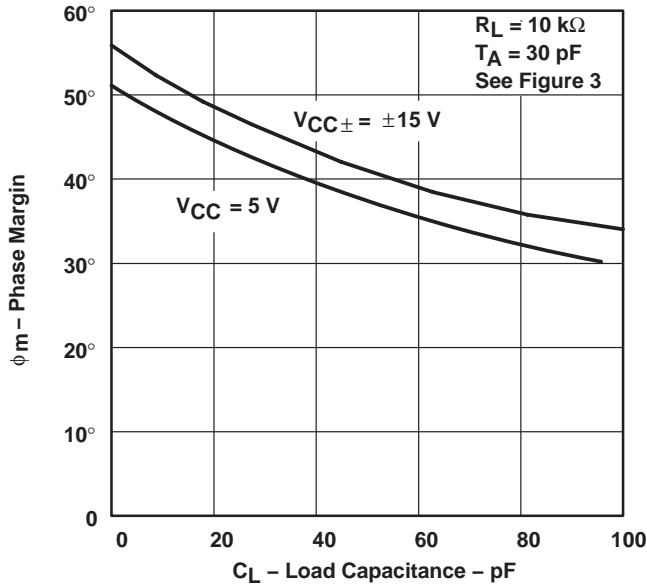

Figure 67

**TLE2022 AND TLE2024
PHASE MARGIN
VS
LOAD CAPACITANCE**

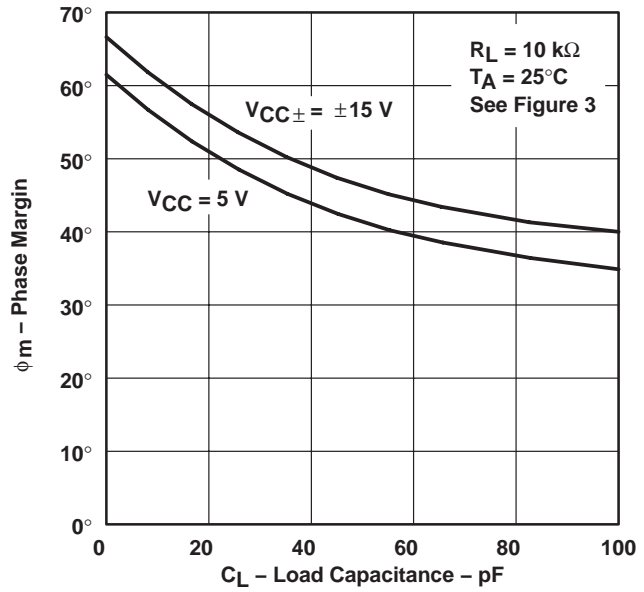

Figure 68

**TLE2021
PHASE MARGIN†
VS
FREE-AIR TEMPERATURE**

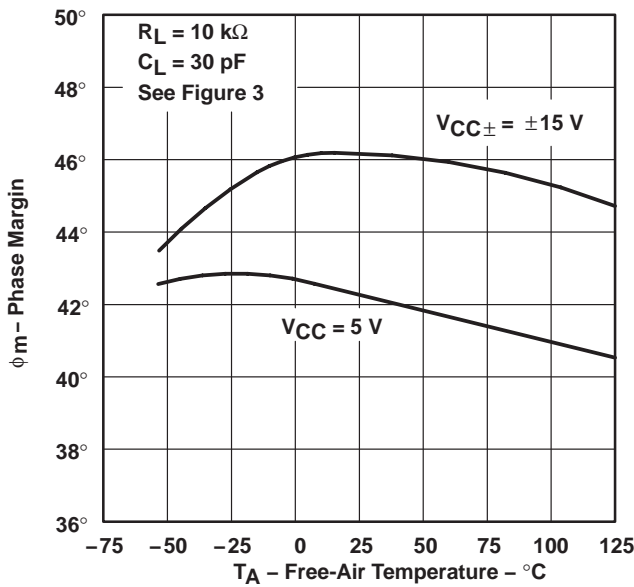

Figure 69

**TLE2022 AND TLE2024
PHASE MARGIN†
VS
FREE-AIR TEMPERATURE**

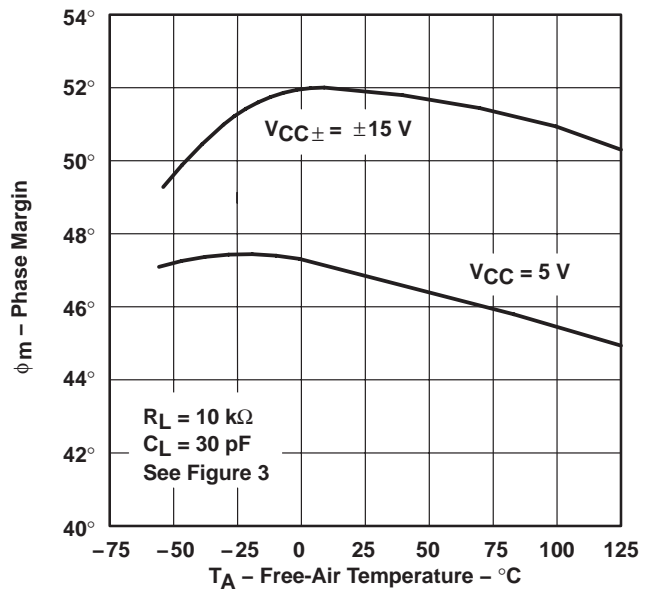

Figure 70

† Data at high and low temperatures are applicable only within the rated operating free-air temperature ranges of the various devices.

APPLICATION INFORMATION

voltage-follower applications

The TLE202x circuitry includes input-protection diodes to limit the voltage across the input transistors; however, no provision is made in the circuit to limit the current if these diodes are forward biased. This condition can occur when the device is operated in the voltage-follower configuration and driven with a fast, large-signal pulse. It is recommended that a feedback resistor be used to limit the current to a maximum of 1 mA to prevent degradation of the device. This feedback resistor forms a pole with the input capacitance of the device. For feedback resistor values greater than 10 k Ω , this pole degrades the amplifier phase margin. This problem can be alleviated by adding a capacitor (20 pF to 50 pF) in parallel with the feedback resistor (see Figure 71).

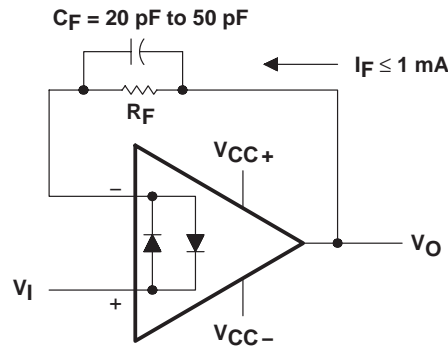

Figure 71. Voltage Follower

Input offset voltage nulling

The TLE202x series offers external null pins that further reduce the input offset voltage. The circuit in Figure 72 can be connected as shown if this feature is desired. When external nulling is not needed, the null pins may be left disconnected.

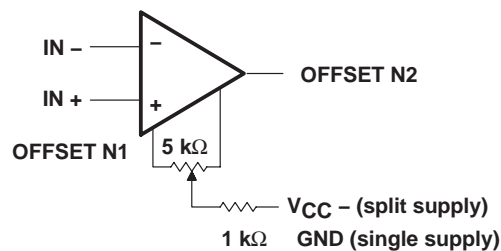

Figure 72. Input Offset Voltage Null Circuit

TLE202x, TLE202xA, TLE202xB, TLE202xY EXCALIBUR HIGH-SPEED LOW-POWER PRECISION OPERATIONAL AMPLIFIERS

SLOS191C – FEBRUARY 1997 – REVISED APRIL 2007

APPLICATION INFORMATION

macromodel information

Macromodel information provided was derived using Microsim *Parts*[™], the model generation software used with Microsim *PSpice*[™]. The Boyle macromodel (see Note 5) and subcircuit in Figure 73, Figure 74, and Figure 75 were generated using the TLE202x typical electrical and operating characteristics at 25°C. Using this information, output simulations of the following key parameters can be generated to a tolerance of 20% (in most cases):

- Maximum positive output voltage swing
- Maximum negative output voltage swing
- Slew rate
- Quiescent power dissipation
- Input bias current
- Open-loop voltage amplification
- Unity-gain frequency
- Common-mode rejection ratio
- Phase margin
- DC output resistance
- AC output resistance
- Short-circuit output current limit

NOTE 5: G. R. Boyle, B. M. Cohn, D. O. Pederson, and J. E. Solomon, "Macromodeling of Integrated Circuit Operational Amplifiers", *IEEE Journal of Solid-State Circuits*, SC-9, 353 (1974).

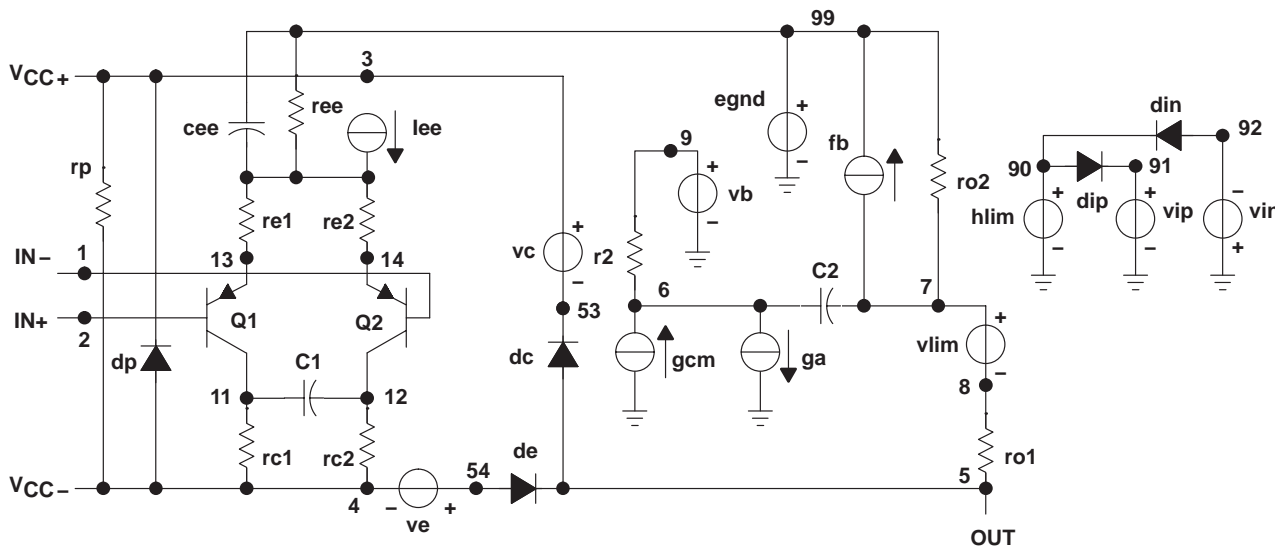

Figure 73. Boyle Subcircuit

PSpice and *Parts* are trademarks of MicroSim Corporation.



POST OFFICE BOX 655303 • DALLAS, TEXAS 75265

TLE202x, TLE202xA, TLE202xB, TLE202xY EXCALIBUR HIGH-SPEED LOW-POWER PRECISION OPERATIONAL AMPLIFIERS

SLOS191C – FEBRUARY 1997 – REVISED APRIL 2007

```
.SUBCKT TLE2021 1 2 3 4 5
*
c1 11 12 6.244E-12
c2 6 7 13.4E-12
c3 87 0 10.64E-9
cpsr 85 86 15.9E-9
dcm+ 81 82 dx
dcm- 83 81 dx
dc 5 53 dx
de 54 5 dx
dlp 90 91 dx
dln 92 90 dx
dp 4 3 dx
ecmr 84 99 (2 99) 1
egnd 99 0 poly(2) (3,0) (4,0) 0 .5 .5
epsr 85 0 poly(1) (3,4) -60E-6 2.0E-6
ense 89 2 poly(1) (88,0) 120E-6 1
fb 7 99 poly(6) vb vc ve vlp vln vpsr 0 547.3E6
+ -50E7 50E7 50E7 -50E7 547E6
ga 6 0 11 12 188.5E-6
gcm 0 6 10 99 335.2E-12
gpsr 85 86 (85,86) 100E-6
grc1 4 11 (4,11) 1.885E-4
grc2 4 12 (4,12) 1.885E-4
gre1 13 10 (13,10) 6.82E-4
gre2 14 10 (14,10) 6.82E-4
hlim 90 0 vlim 1k

hcmr 80 1 poly(2) vcm+ vcm- 0 1E2 1E2
irp 3 4 185E-6
iee 3 10 dc 15.67E-6
iio 2 0 2E-9
i1 88 0 1E-21
q1 11 89 13 qx
q2 12 80 14 qx
R2 6 9 100.0E3
rcm 84 81 1K
ree 10 99 14.76E6
rn1 87 0 2.55E8
rn2 87 88 11.67E3
ro1 8 5 62
ro2 7 99 63
vcm+ 82 99 13.3
vcm- 83 99 -14.6
vb 9 0 dc 0
vc 3 53 dc 1.300
ve 54 4 dc 1.500
vlim 7 8 dc 0
vlp 91 0 dc 3.600
vln 0 92 dc 3.600
vpsr 0 86 dc 0
.model dx d(is=800.0E-18)
.model qx pnp(is=800.0E-18 bf=270)
.ends
```

Figure 74. Boyle Macromodel for the TLE2021

```
.SUBCKT TLE2022 1 2 3 4 5
*
c1 11 12 6.814E-12
c2 6 7 20.00E-12
dc 5 53 dx
de 54 5 dx
dlp 90 91 dx
dln 92 90 dx
dp 4 3 dx
egnd 99 0 poly(2) (3,0) (4,0) 0 .5 .5
fb 7 99 poly(5) vb vc ve vlp vln 0
+ 45.47E6 -50E6 50E6 50E6 -50E6
ga 6 0 11 12 377.9E-6
gcm 0 6 10 99 7.84E-10
iee 3 10 DC 18.07E-6
hlim 90 0 vlim 1k
q1 11 2 13 qx
q2 12 1 14 qx
r2 6 9 100.0E3

rc1 4 11 2.842E3
rc2 4 12 2.842E3
ge1 13 10 (10,13) 31.299E-3
ge2 14 10 (10,14) 31.299E-3
ree 10 99 11.07E6
ro1 8 5 250
ro2 7 99 250
rp 3 4 137.2E3
vb 9 0 dc 0
vc 3 53 dc 1.300
ve 54 4 dc 1.500
vlim 7 8 dc 0
vlp 91 0 dc 3
vln 0 92 dc 3
.model dx d(is=800.0E-18)
.model qx pnp(is=800.0E-18 bf=257.1)
.ends
```

Figure 75. Boyle Macromodel for the TLE2022

PACKAGING INFORMATION

Orderable Device	Status ⁽¹⁾	Package Type	Package Drawing	Pins	Package Qty	Eco Plan ⁽²⁾	Lead/Ball Finish	MSL Peak Temp ⁽³⁾
5962-9088101M2A	ACTIVE	LCCC	FK	20		TBD	Call TI	Call TI
5962-9088101MPA	ACTIVE	CDIP	JG	8	1	TBD	A42 SNPB	N / A for Pkg Type
5962-9088102M2A	ACTIVE	LCCC	FK	20	1	TBD	POST-PLATE	N / A for Pkg Type
5962-9088102MPA	ACTIVE	CDIP	JG	8	1	TBD	A42 SNPB	N / A for Pkg Type
5962-9088103M2A	ACTIVE	LCCC	FK	20	1	TBD	POST-PLATE	N / A for Pkg Type
5962-9088103MCA	ACTIVE	CDIP	J	14	1	TBD	A42 SNPB	N / A for Pkg Type
5962-9088104Q2A	ACTIVE	LCCC	FK	20	1	TBD	POST-PLATE	N / A for Pkg Type
5962-9088104QPA	ACTIVE	CDIP	JG	8	1	TBD	A42 SNPB	N / A for Pkg Type
5962-9088105Q2A	ACTIVE	LCCC	FK	20	1	TBD	POST-PLATE	N / A for Pkg Type
5962-9088105QPA	ACTIVE	CDIP	JG	8	1	TBD	A42 SNPB	N / A for Pkg Type
5962-9088106Q2A	ACTIVE	LCCC	FK	20	1	TBD	POST-PLATE	N / A for Pkg Type
5962-9088106QCA	ACTIVE	CDIP	J	14	1	TBD	A42 SNPB	N / A for Pkg Type
5962-9088107Q2A	ACTIVE	LCCC	FK	20	1	TBD	POST-PLATE	N / A for Pkg Type
5962-9088107QPA	ACTIVE	CDIP	JG	8	1	TBD	A42 SNPB	N / A for Pkg Type
5962-9088108Q2A	ACTIVE	LCCC	FK	20	1	TBD	POST-PLATE	N / A for Pkg Type
5962-9088108QPA	ACTIVE	CDIP	JG	8	1	TBD	A42 SNPB	N / A for Pkg Type
5962-9088109Q2A	ACTIVE	LCCC	FK	20	1	TBD	POST-PLATE	N / A for Pkg Type
5962-9088109QCA	ACTIVE	CDIP	J	14	1	TBD	A42 SNPB	N / A for Pkg Type
TLE2021ACD	ACTIVE	SOIC	D	8	75	Green (RoHS & no Sb/Br)	CU NIPDAU	Level-1-260C-UNLIM
TLE2021ACDG4	ACTIVE	SOIC	D	8	75	Green (RoHS & no Sb/Br)	CU NIPDAU	Level-1-260C-UNLIM
TLE2021ACDR	ACTIVE	SOIC	D	8	2500	Green (RoHS & no Sb/Br)	CU NIPDAU	Level-1-260C-UNLIM
TLE2021ACDRG4	ACTIVE	SOIC	D	8	2500	Green (RoHS & no Sb/Br)	CU NIPDAU	Level-1-260C-UNLIM
TLE2021ACP	ACTIVE	PDIP	P	8	50	Pb-Free (RoHS)	CU NIPDAU	N / A for Pkg Type
TLE2021ACPE4	ACTIVE	PDIP	P	8	50	Pb-Free (RoHS)	CU NIPDAU	N / A for Pkg Type
TLE2021ACPS	OBSOLETE	SO	PS	8		TBD	Call TI	Call TI
TLE2021ACPSG4	OBSOLETE	SO	PS	8		TBD	Call TI	Call TI
TLE2021AID	ACTIVE	SOIC	D	8	75	Green (RoHS & no Sb/Br)	CU NIPDAU	Level-1-260C-UNLIM
TLE2021AIDG4	ACTIVE	SOIC	D	8	75	Green (RoHS & no Sb/Br)	CU NIPDAU	Level-1-260C-UNLIM
TLE2021AIP	ACTIVE	PDIP	P	8	50	Pb-Free (RoHS)	CU NIPDAU	N / A for Pkg Type
TLE2021AIPE4	ACTIVE	PDIP	P	8	50	Pb-Free (RoHS)	CU NIPDAU	N / A for Pkg Type
TLE2021AMFKB	ACTIVE	LCCC	FK	20	1	TBD	POST-PLATE	N / A for Pkg Type
TLE2021AMJGB	ACTIVE	CDIP	JG	8	1	TBD	A42 SNPB	N / A for Pkg Type
TLE2021BMFKB	ACTIVE	LCCC	FK	20	1	TBD	POST-PLATE	N / A for Pkg Type
TLE2021BMJG	ACTIVE	CDIP	JG	8	1	TBD	A42 SNPB	N / A for Pkg Type
TLE2021BMJGB	ACTIVE	CDIP	JG	8	1	TBD	A42 SNPB	N / A for Pkg Type

Orderable Device	Status ⁽¹⁾	Package Type	Package Drawing	Pins	Package Qty	Eco Plan ⁽²⁾	Lead/Ball Finish	MSL Peak Temp ⁽³⁾
TLE2021CD	ACTIVE	SOIC	D	8	75	Green (RoHS & no Sb/Br)	CU NIPDAU	Level-1-260C-UNLIM
TLE2021CDG4	ACTIVE	SOIC	D	8	75	Green (RoHS & no Sb/Br)	CU NIPDAU	Level-1-260C-UNLIM
TLE2021CDR	ACTIVE	SOIC	D	8	2500	Green (RoHS & no Sb/Br)	CU NIPDAU	Level-1-260C-UNLIM
TLE2021CDRG4	ACTIVE	SOIC	D	8	2500	Green (RoHS & no Sb/Br)	CU NIPDAU	Level-1-260C-UNLIM
TLE2021CP	ACTIVE	PDIP	P	8	50	Pb-Free (RoHS)	CU NIPDAU	N / A for Pkg Type
TLE2021CPE4	ACTIVE	PDIP	P	8	50	Pb-Free (RoHS)	CU NIPDAU	N / A for Pkg Type
TLE2021CPWLE	OBSOLETE	TSSOP	PW	8		TBD	Call TI	Call TI
TLE2021CPWR	ACTIVE	TSSOP	PW	8	2000	Green (RoHS & no Sb/Br)	CU NIPDAU	Level-1-260C-UNLIM
TLE2021CPWRG4	ACTIVE	TSSOP	PW	8	2000	Green (RoHS & no Sb/Br)	CU NIPDAU	Level-1-260C-UNLIM
TLE2021ID	ACTIVE	SOIC	D	8	75	Green (RoHS & no Sb/Br)	CU NIPDAU	Level-1-260C-UNLIM
TLE2021IDG4	ACTIVE	SOIC	D	8	75	Green (RoHS & no Sb/Br)	CU NIPDAU	Level-1-260C-UNLIM
TLE2021IDR	ACTIVE	SOIC	D	8	2500	Green (RoHS & no Sb/Br)	CU NIPDAU	Level-1-260C-UNLIM
TLE2021IDRG4	ACTIVE	SOIC	D	8	2500	Green (RoHS & no Sb/Br)	CU NIPDAU	Level-1-260C-UNLIM
TLE2021IP	ACTIVE	PDIP	P	8	50	Pb-Free (RoHS)	CU NIPDAU	N / A for Pkg Type
TLE2021IPE4	ACTIVE	PDIP	P	8	50	Pb-Free (RoHS)	CU NIPDAU	N / A for Pkg Type
TLE2021MD	ACTIVE	SOIC	D	8	75	TBD	CU NIPDAU	Level-1-220C-UNLIM
TLE2021MDG4	ACTIVE	SOIC	D	8	75	Green (RoHS & no Sb/Br)	CU NIPDAU	Level-1-260C-UNLIM
TLE2021MFKB	OBSOLETE	LCCC	FK	20		TBD	Call TI	Call TI
TLE2021MJG	ACTIVE	CDIP	JG	8	1	TBD	A42 SNPB	N / A for Pkg Type
TLE2021MJGB	ACTIVE	CDIP	JG	8	1	TBD	A42 SNPB	N / A for Pkg Type
TLE2022ACD	ACTIVE	SOIC	D	8	75	Green (RoHS & no Sb/Br)	CU NIPDAU	Level-1-260C-UNLIM
TLE2022ACDG4	ACTIVE	SOIC	D	8	75	Green (RoHS & no Sb/Br)	CU NIPDAU	Level-1-260C-UNLIM
TLE2022ACDR	ACTIVE	SOIC	D	8	2500	Green (RoHS & no Sb/Br)	CU NIPDAU	Level-1-260C-UNLIM
TLE2022ACDRG4	ACTIVE	SOIC	D	8	2500	Green (RoHS & no Sb/Br)	CU NIPDAU	Level-1-260C-UNLIM
TLE2022ACP	ACTIVE	PDIP	P	8	50	Pb-Free (RoHS)	CU NIPDAU	N / A for Pkg Type
TLE2022ACPE4	ACTIVE	PDIP	P	8	50	Pb-Free (RoHS)	CU NIPDAU	N / A for Pkg Type
TLE2022AID	ACTIVE	SOIC	D	8	75	Green (RoHS & no Sb/Br)	CU NIPDAU	Level-1-260C-UNLIM
TLE2022AIDG4	ACTIVE	SOIC	D	8	75	Green (RoHS & no Sb/Br)	CU NIPDAU	Level-1-260C-UNLIM

Orderable Device	Status ⁽¹⁾	Package Type	Package Drawing	Pins	Package Qty	Eco Plan ⁽²⁾	Lead/Ball Finish	MSL Peak Temp ⁽³⁾
TLE2022AIDR	ACTIVE	SOIC	D	8	2500	Green (RoHS & no Sb/Br)	CU NIPDAU	Level-1-260C-UNLIM
TLE2022AIDRG4	ACTIVE	SOIC	D	8	2500	Green (RoHS & no Sb/Br)	CU NIPDAU	Level-1-260C-UNLIM
TLE2022AIP	ACTIVE	PDIP	P	8	50	Pb-Free (RoHS)	CU NIPDAU	N / A for Pkg Type
TLE2022AIPE4	ACTIVE	PDIP	P	8	50	Pb-Free (RoHS)	CU NIPDAU	N / A for Pkg Type
TLE2022AMD	ACTIVE	SOIC	D	8	75	TBD	CU NIPDAU	Level-1-220C-UNLIM
TLE2022AMDG4	ACTIVE	SOIC	D	8	75	Green (RoHS & no Sb/Br)	CU NIPDAU	Level-1-260C-UNLIM
TLE2022AMDR	ACTIVE	SOIC	D	8	2500	TBD	CU NIPDAU	Level-1-220C-UNLIM
TLE2022AMDRG4	ACTIVE	SOIC	D	8	2500	Green (RoHS & no Sb/Br)	CU NIPDAU	Level-1-260C-UNLIM
TLE2022AMFKB	ACTIVE	LCCC	FK	20	1	TBD	POST-PLATE	N / A for Pkg Type
TLE2022AMJG	OBSOLETE	CDIP	JG	8		TBD	Call TI	Call TI
TLE2022AMJGB	ACTIVE	CDIP	JG	8	1	TBD	A42 SNPB	N / A for Pkg Type
TLE2022BCDR	OBSOLETE	SOIC	D	8		TBD	Call TI	Call TI
TLE2022BMFKB	ACTIVE	LCCC	FK	20	1	TBD	POST-PLATE	N / A for Pkg Type
TLE2022BMJG	OBSOLETE	CDIP	JG	8		TBD	Call TI	Call TI
TLE2022BMJGB	ACTIVE	CDIP	JG	8	1	TBD	A42 SNPB	N / A for Pkg Type
TLE2022CD	ACTIVE	SOIC	D	8	75	Green (RoHS & no Sb/Br)	CU NIPDAU	Level-1-260C-UNLIM
TLE2022CDG4	ACTIVE	SOIC	D	8	75	Green (RoHS & no Sb/Br)	CU NIPDAU	Level-1-260C-UNLIM
TLE2022CDR	ACTIVE	SOIC	D	8	2500	Green (RoHS & no Sb/Br)	CU NIPDAU	Level-1-260C-UNLIM
TLE2022CDRG4	ACTIVE	SOIC	D	8	2500	Green (RoHS & no Sb/Br)	CU NIPDAU	Level-1-260C-UNLIM
TLE2022CP	ACTIVE	PDIP	P	8	50	Pb-Free (RoHS)	CU NIPDAU	N / A for Pkg Type
TLE2022CPE4	ACTIVE	PDIP	P	8	50	Pb-Free (RoHS)	CU NIPDAU	N / A for Pkg Type
TLE2022CPSR	OBSOLETE	SO	PS	8		TBD	Call TI	Call TI
TLE2022ID	ACTIVE	SOIC	D	8	75	Green (RoHS & no Sb/Br)	CU NIPDAU	Level-1-260C-UNLIM
TLE2022IDG4	ACTIVE	SOIC	D	8	75	Green (RoHS & no Sb/Br)	CU NIPDAU	Level-1-260C-UNLIM
TLE2022IDR	ACTIVE	SOIC	D	8	2500	Green (RoHS & no Sb/Br)	CU NIPDAU	Level-1-260C-UNLIM
TLE2022IDRG4	ACTIVE	SOIC	D	8	2500	Green (RoHS & no Sb/Br)	CU NIPDAU	Level-1-260C-UNLIM
TLE2022IP	ACTIVE	PDIP	P	8	50	Pb-Free (RoHS)	CU NIPDAU	N / A for Pkg Type
TLE2022IPE4	ACTIVE	PDIP	P	8	50	Pb-Free (RoHS)	CU NIPDAU	N / A for Pkg Type
TLE2022MD	ACTIVE	SOIC	D	8	75	TBD	CU NIPDAU	Level-1-220C-UNLIM
TLE2022MDG4	ACTIVE	SOIC	D	8	75	Green (RoHS & no Sb/Br)	CU NIPDAU	Level-1-260C-UNLIM

Orderable Device	Status ⁽¹⁾	Package Type	Package Drawing	Pins	Package Qty	Eco Plan ⁽²⁾	Lead/Ball Finish	MSL Peak Temp ⁽³⁾
TLE2022MDR	ACTIVE	SOIC	D	8	2500	TBD	CU NIPDAU	Level-1-220C-UNLIM
TLE2022MDRG4	ACTIVE	SOIC	D	8	2500	Green (RoHS & no Sb/Br)	CU NIPDAU	Level-1-260C-UNLIM
TLE2022MFKB	ACTIVE	LCCC	FK	20	1	TBD	POST-PLATE	N / A for Pkg Type
TLE2022MJG	ACTIVE	CDIP	JG	8	1	TBD	A42 SNPB	N / A for Pkg Type
TLE2022MJGB	ACTIVE	CDIP	JG	8	1	TBD	A42 SNPB	N / A for Pkg Type
TLE2024ACDW	ACTIVE	SOIC	DW	16	40	Green (RoHS & no Sb/Br)	CU NIPDAU	Level-1-260C-UNLIM
TLE2024ACDWG4	ACTIVE	SOIC	DW	16	40	Green (RoHS & no Sb/Br)	CU NIPDAU	Level-1-260C-UNLIM
TLE2024ACDWR	ACTIVE	SOIC	DW	16	2000	Green (RoHS & no Sb/Br)	CU NIPDAU	Level-1-260C-UNLIM
TLE2024ACDWRG4	ACTIVE	SOIC	DW	16	2000	Green (RoHS & no Sb/Br)	CU NIPDAU	Level-1-260C-UNLIM
TLE2024ACN	ACTIVE	PDIP	N	14	25	Pb-Free (RoHS)	CU NIPDAU	N / A for Pkg Type
TLE2024ACNE4	ACTIVE	PDIP	N	14	25	Pb-Free (RoHS)	CU NIPDAU	N / A for Pkg Type
TLE2024AIDW	ACTIVE	SOIC	DW	16	40	Green (RoHS & no Sb/Br)	CU NIPDAU	Level-1-260C-UNLIM
TLE2024AIDWG4	ACTIVE	SOIC	DW	16	40	Green (RoHS & no Sb/Br)	CU NIPDAU	Level-1-260C-UNLIM
TLE2024AIN	ACTIVE	PDIP	N	14	25	Pb-Free (RoHS)	CU NIPDAU	N / A for Pkg Type
TLE2024AINE4	ACTIVE	PDIP	N	14	25	Pb-Free (RoHS)	CU NIPDAU	N / A for Pkg Type
TLE2024AMFK	ACTIVE	LCCC	FK	20	1	TBD	POST-PLATE	N / A for Pkg Type
TLE2024AMFKB	ACTIVE	LCCC	FK	20	1	TBD	POST-PLATE	N / A for Pkg Type
TLE2024AMJ	ACTIVE	CDIP	J	14	1	TBD	A42 SNPB	N / A for Pkg Type
TLE2024AMJB	ACTIVE	CDIP	J	14	1	TBD	A42 SNPB	N / A for Pkg Type
TLE2024BCDW	OBSOLETE	SOIC	DW	16		TBD	Call TI	Call TI
TLE2024BCN	OBSOLETE	PDIP	N	14		TBD	Call TI	Call TI
TLE2024BIDW	OBSOLETE	SOIC	DW	16		TBD	Call TI	Call TI
TLE2024BIN	OBSOLETE	PDIP	N	14		TBD	Call TI	Call TI
TLE2024BMDW	ACTIVE	SOIC	DW	16	40	TBD	CU NIPDAU	Level-1-220C-UNLIM
TLE2024BMDWG4	ACTIVE	SOIC	DW	16	40	TBD	Call TI	Call TI
TLE2024BMFKB	ACTIVE	LCCC	FK	20	1	TBD	POST-PLATE	N / A for Pkg Type
TLE2024BMJ	NRND	CDIP	J	14	1	TBD	A42 SNPB	N / A for Pkg Type
TLE2024BMJB	ACTIVE	CDIP	J	14	1	TBD	A42 SNPB	N / A for Pkg Type
TLE2024BMN	OBSOLETE	PDIP	N	14		TBD	Call TI	Call TI
TLE2024CDW	ACTIVE	SOIC	DW	16	40	Green (RoHS & no Sb/Br)	CU NIPDAU	Level-1-260C-UNLIM
TLE2024CDWG4	ACTIVE	SOIC	DW	16	40	Green (RoHS & no Sb/Br)	CU NIPDAU	Level-1-260C-UNLIM
TLE2024CDWR	ACTIVE	SOIC	DW	16	2000	Green (RoHS & no Sb/Br)	CU NIPDAU	Level-1-260C-UNLIM
TLE2024CDWRG4	ACTIVE	SOIC	DW	16	2000	Green (RoHS & no Sb/Br)	CU NIPDAU	Level-1-260C-UNLIM

Orderable Device	Status ⁽¹⁾	Package Type	Package Drawing	Pins	Package Qty	Eco Plan ⁽²⁾	Lead/Ball Finish	MSL Peak Temp ⁽³⁾
TLE2024CN	ACTIVE	PDIP	N	14	25	Pb-Free (RoHS)	CU NIPDAU	N / A for Pkg Type
TLE2024CNE4	ACTIVE	PDIP	N	14	25	Pb-Free (RoHS)	CU NIPDAU	N / A for Pkg Type
TLE2024IDW	ACTIVE	SOIC	DW	16	40	Green (RoHS & no Sb/Br)	CU NIPDAU	Level-1-260C-UNLIM
TLE2024IDWG4	ACTIVE	SOIC	DW	16	40	Green (RoHS & no Sb/Br)	CU NIPDAU	Level-1-260C-UNLIM
TLE2024IN	ACTIVE	PDIP	N	14	25	Pb-Free (RoHS)	CU NIPDAU	N / A for Pkg Type
TLE2024INE4	ACTIVE	PDIP	N	14	25	Pb-Free (RoHS)	CU NIPDAU	N / A for Pkg Type
TLE2024MDW	ACTIVE	SOIC	DW	16	40	TBD	CU NIPDAU	Level-1-220C-UNLIM
TLE2024MDWG4	ACTIVE	SOIC	DW	16	40	Green (RoHS & no Sb/Br)	CU NIPDAU	Level-1-260C-UNLIM
TLE2024MFKB	ACTIVE	LCCC	FK	20	1	TBD	POST-PLATE	N / A for Pkg Type
TLE2024MJ	OBSOLETE	CDIP	J	14		TBD	Call TI	Call TI
TLE2024MJB	ACTIVE	CDIP	J	14	1	TBD	A42 SNPB	N / A for Pkg Type
TLE2024MN	OBSOLETE	PDIP	N	14		TBD	Call TI	Call TI

⁽¹⁾ The marketing status values are defined as follows:

ACTIVE: Product device recommended for new designs.

LIFEBUY: TI has announced that the device will be discontinued, and a lifetime-buy period is in effect.

NRND: Not recommended for new designs. Device is in production to support existing customers, but TI does not recommend using this part in a new design.

PREVIEW: Device has been announced but is not in production. Samples may or may not be available.

OBSOLETE: TI has discontinued the production of the device.

⁽²⁾ Eco Plan - The planned eco-friendly classification: Pb-Free (RoHS), Pb-Free (RoHS Exempt), or Green (RoHS & no Sb/Br) - please check <http://www.ti.com/productcontent> for the latest availability information and additional product content details.

TBD: The Pb-Free/Green conversion plan has not been defined.

Pb-Free (RoHS): TI's terms "Lead-Free" or "Pb-Free" mean semiconductor products that are compatible with the current RoHS requirements for all 6 substances, including the requirement that lead not exceed 0.1% by weight in homogeneous materials. Where designed to be soldered at high temperatures, TI Pb-Free products are suitable for use in specified lead-free processes.

Pb-Free (RoHS Exempt): This component has a RoHS exemption for either 1) lead-based flip-chip solder bumps used between the die and package, or 2) lead-based die adhesive used between the die and leadframe. The component is otherwise considered Pb-Free (RoHS compatible) as defined above.

Green (RoHS & no Sb/Br): TI defines "Green" to mean Pb-Free (RoHS compatible), and free of Bromine (Br) and Antimony (Sb) based flame retardants (Br or Sb do not exceed 0.1% by weight in homogeneous material)

⁽³⁾ MSL, Peak Temp. -- The Moisture Sensitivity Level rating according to the JEDEC industry standard classifications, and peak solder temperature.

Important Information and Disclaimer:The information provided on this page represents TI's knowledge and belief as of the date that it is provided. TI bases its knowledge and belief on information provided by third parties, and makes no representation or warranty as to the accuracy of such information. Efforts are underway to better integrate information from third parties. TI has taken and continues to take reasonable steps to provide representative and accurate information but may not have conducted destructive testing or chemical analysis on incoming materials and chemicals. TI and TI suppliers consider certain information to be proprietary, and thus CAS numbers and other limited information may not be available for release.

In no event shall TI's liability arising out of such information exceed the total purchase price of the TI part(s) at issue in this document sold by TI to Customer on an annual basis.

OTHER QUALIFIED VERSIONS OF TLE2021, TLE2021A, TLE2021AM, TLE2021M, TLE2022, TLE2022A, TLE2022AM, TLE2022B, TLE2022BM, TLE2022M, TLE2024, TLE2024A, TLE2024AM, TLE2024B, TLE2024BM, TLE2024M :

- Automotive: [TLE2021-Q1](#), [TLE2021A-Q1](#), [TLE2022-Q1](#), [TLE2022A-Q1](#), [TLE2024-Q1](#), [TLE2024A-Q1](#)
- Enhanced Product: [TLE2021-EP](#), [TLE2021A-EP](#), [TLE2022-EP](#), [TLE2022A-EP](#), [TLE2024-EP](#), [TLE2024A-EP](#)

NOTE: Qualified Version Definitions:

- Automotive - Q100 devices qualified for high-reliability automotive applications targeting zero defects
- Enhanced Product - Supports Defense, Aerospace and Medical Applications

TAPE AND REEL INFORMATION



QUADRANT ASSIGNMENTS FOR PIN 1 ORIENTATION IN TAPE



*All dimensions are nominal

Device	Package Type	Package Drawing	Pins	SPQ	Reel Diameter (mm)	Reel Width W1 (mm)	A0 (mm)	B0 (mm)	K0 (mm)	P1 (mm)	W (mm)	Pin1 Quadrant
TLE2021ACDR	SOIC	D	8	2500	330.0	12.4	6.4	5.2	2.1	8.0	12.0	Q1
TLE2021CDR	SOIC	D	8	2500	330.0	12.4	6.4	5.2	2.1	8.0	12.0	Q1
TLE2021CPWR	TSSOP	PW	8	2000	330.0	12.4	7.0	3.6	1.6	8.0	12.0	Q1
TLE2021IDR	SOIC	D	8	2500	330.0	12.4	6.4	5.2	2.1	8.0	12.0	Q1
TLE2022ACDR	SOIC	D	8	2500	330.0	12.4	6.4	5.2	2.1	8.0	12.0	Q1
TLE2022AIDR	SOIC	D	8	2500	330.0	12.4	6.4	5.2	2.1	8.0	12.0	Q1
TLE2022AIDR	SOIC	D	8	2500	330.0	12.4	6.4	5.2	2.1	8.0	12.0	Q1
TLE2022CDR	SOIC	D	8	2500	330.0	12.4	6.4	5.2	2.1	8.0	12.0	Q1
TLE2022CDR	SOIC	D	8	2500	330.0	12.4	6.4	5.2	2.1	8.0	12.0	Q1
TLE2022IDR	SOIC	D	8	2500	330.0	12.4	6.4	5.2	2.1	8.0	12.0	Q1
TLE2024ACDWR	SOIC	DW	16	2000	330.0	16.4	10.75	10.7	2.7	12.0	16.0	Q1
TLE2024CDWR	SOIC	DW	16	2000	330.0	16.4	10.75	10.7	2.7	12.0	16.0	Q1

TAPE AND REEL BOX DIMENSIONS



*All dimensions are nominal

Device	Package Type	Package Drawing	Pins	SPQ	Length (mm)	Width (mm)	Height (mm)
TLE2021ACDR	SOIC	D	8	2500	346.0	346.0	29.0
TLE2021CDR	SOIC	D	8	2500	346.0	346.0	29.0
TLE2021CPWR	TSSOP	PW	8	2000	346.0	346.0	29.0
TLE2021IDR	SOIC	D	8	2500	346.0	346.0	29.0
TLE2022ACDR	SOIC	D	8	2500	340.5	338.1	20.6
TLE2022AIDR	SOIC	D	8	2500	346.0	346.0	29.0
TLE2022AIDR	SOIC	D	8	2500	340.5	338.1	20.6
TLE2022CDR	SOIC	D	8	2500	340.5	338.1	20.6
TLE2022CDR	SOIC	D	8	2500	346.0	346.0	29.0
TLE2022IDR	SOIC	D	8	2500	340.5	338.1	20.6
TLE2024ACDWR	SOIC	DW	16	2000	346.0	346.0	33.0
TLE2024CDWR	SOIC	DW	16	2000	346.0	346.0	33.0

FK (S-CQCC-N**)

LEADLESS CERAMIC CHIP CARRIER

28 TERMINAL SHOWN



4040140/D 10/96

- NOTES:
- A. All linear dimensions are in inches (millimeters).
 - B. This drawing is subject to change without notice.
 - C. This package can be hermetically sealed with a metal lid.
 - D. The terminals are gold plated.
 - E. Falls within JEDEC MS-004

J (R-GDIP-T**)

14 LEADS SHOWN

CERAMIC DUAL IN-LINE PACKAGE



DIM \ PINS **	14	16	18	20
A	0.300 (7,62) BSC	0.300 (7,62) BSC	0.300 (7,62) BSC	0.300 (7,62) BSC
B MAX	0.785 (19,94)	.840 (21,34)	0.960 (24,38)	1.060 (26,92)
B MIN	—	—	—	—
C MAX	0.300 (7,62)	0.300 (7,62)	0.310 (7,87)	0.300 (7,62)
C MIN	0.245 (6,22)	0.245 (6,22)	0.220 (5,59)	0.245 (6,22)



4040083/F 03/03

- NOTES:
- All linear dimensions are in inches (millimeters).
 - This drawing is subject to change without notice.
 - This package is hermetically sealed with a ceramic lid using glass frit.
 - Index point is provided on cap for terminal identification only on press ceramic glass frit seal only.
 - Falls within MIL STD 1835 GDIP1-T14, GDIP1-T16, GDIP1-T18 and GDIP1-T20.

PW (R-PDSO-G**)

PLASTIC SMALL-OUTLINE PACKAGE

14 PINS SHOWN



4040064/F 01/97

- NOTES: A. All linear dimensions are in millimeters.
 B. This drawing is subject to change without notice.
 C. Body dimensions do not include mold flash or protrusion not to exceed 0,15.
 D. Falls within JEDEC MO-153

MECHANICAL DATA

PS (R-PDSO-G8)

PLASTIC SMALL-OUTLINE PACKAGE



- NOTES:
- A. All linear dimensions are in millimeters.
 - B. This drawing is subject to change without notice.
 - C. Body dimensions do not include mold flash or protrusion, not to exceed 0,15.

D (R-PDSO-G8)

PLASTIC SMALL-OUTLINE PACKAGE



- NOTES:
- A. All linear dimensions are in inches (millimeters).
 - B. This drawing is subject to change without notice.
 - C. Body length does not include mold flash, protrusions, or gate burrs. Mold flash, protrusions, or gate burrs shall not exceed .006 (0,15) per end.
 - D. Body width does not include interlead flash. Interlead flash shall not exceed .017 (0,43) per side.
 - E. Reference JEDEC MS-012 variation AA.

P (R-PDIP-T8)

PLASTIC DUAL-IN-LINE



- NOTES: A. All linear dimensions are in inches (millimeters).
 B. This drawing is subject to change without notice.
 C. Falls within JEDEC MS-001

For the latest package information, go to http://www.ti.com/sc/docs/package/pkg_info.htm

DW (R-PDSO-G16)

PLASTIC SMALL-OUTLINE PACKAGE

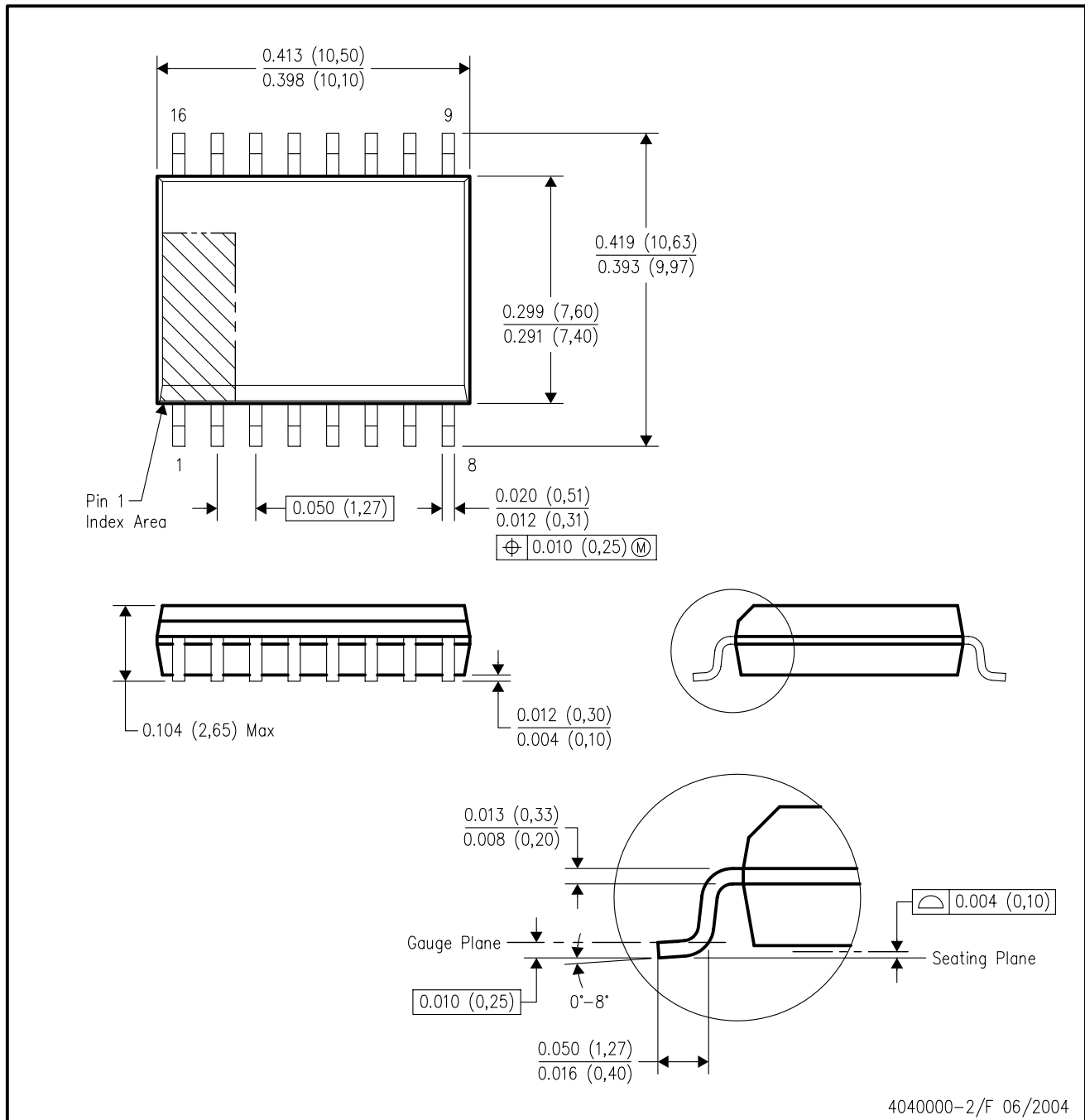

4040000-2/F 06/2004

- NOTES:
- A. All linear dimensions are in inches (millimeters).
 - B. This drawing is subject to change without notice.
 - C. Body dimensions do not include mold flash or protrusion not to exceed 0.006 (0,15).
 - D. Falls within JEDEC MS-013 variation AA.

JG (R-GDIP-T8)

CERAMIC DUAL-IN-LINE



- NOTES: A. All linear dimensions are in inches (millimeters).
 B. This drawing is subject to change without notice.
 C. This package can be hermetically sealed with a ceramic lid using glass frit.
 D. Index point is provided on cap for terminal identification.
 E. Falls within MIL STD 1835 GDIP1-T8

IMPORTANT NOTICE

Texas Instruments Incorporated and its subsidiaries (TI) reserve the right to make corrections, modifications, enhancements, improvements, and other changes to its products and services at any time and to discontinue any product or service without notice. Customers should obtain the latest relevant information before placing orders and should verify that such information is current and complete. All products are sold subject to TI's terms and conditions of sale supplied at the time of order acknowledgment.

TI warrants performance of its hardware products to the specifications applicable at the time of sale in accordance with TI's standard warranty. Testing and other quality control techniques are used to the extent TI deems necessary to support this warranty. Except where mandated by government requirements, testing of all parameters of each product is not necessarily performed.

TI assumes no liability for applications assistance or customer product design. Customers are responsible for their products and applications using TI components. To minimize the risks associated with customer products and applications, customers should provide adequate design and operating safeguards.

TI does not warrant or represent that any license, either express or implied, is granted under any TI patent right, copyright, mask work right, or other TI intellectual property right relating to any combination, machine, or process in which TI products or services are used. Information published by TI regarding third-party products or services does not constitute a license from TI to use such products or services or a warranty or endorsement thereof. Use of such information may require a license from a third party under the patents or other intellectual property of the third party, or a license from TI under the patents or other intellectual property of TI.

Reproduction of TI information in TI data books or data sheets is permissible only if reproduction is without alteration and is accompanied by all associated warranties, conditions, limitations, and notices. Reproduction of this information with alteration is an unfair and deceptive business practice. TI is not responsible or liable for such altered documentation. Information of third parties may be subject to additional restrictions.

Resale of TI products or services with statements different from or beyond the parameters stated by TI for that product or service voids all express and any implied warranties for the associated TI product or service and is an unfair and deceptive business practice. TI is not responsible or liable for any such statements.

TI products are not authorized for use in safety-critical applications (such as life support) where a failure of the TI product would reasonably be expected to cause severe personal injury or death, unless officers of the parties have executed an agreement specifically governing such use. Buyers represent that they have all necessary expertise in the safety and regulatory ramifications of their applications, and acknowledge and agree that they are solely responsible for all legal, regulatory and safety-related requirements concerning their products and any use of TI products in such safety-critical applications, notwithstanding any applications-related information or support that may be provided by TI. Further, Buyers must fully indemnify TI and its representatives against any damages arising out of the use of TI products in such safety-critical applications.

TI products are neither designed nor intended for use in military/aerospace applications or environments unless the TI products are specifically designated by TI as military-grade or "enhanced plastic." Only products designated by TI as military-grade meet military specifications. Buyers acknowledge and agree that any such use of TI products which TI has not designated as military-grade is solely at the Buyer's risk, and that they are solely responsible for compliance with all legal and regulatory requirements in connection with such use.

TI products are neither designed nor intended for use in automotive applications or environments unless the specific TI products are designated by TI as compliant with ISO/TS 16949 requirements. Buyers acknowledge and agree that, if they use any non-designated products in automotive applications, TI will not be responsible for any failure to meet such requirements.

Following are URLs where you can obtain information on other Texas Instruments products and application solutions:

Products

Amplifiers	amplifier.ti.com
Data Converters	dataconverter.ti.com
DSP	dsp.ti.com
Clocks and Timers	www.ti.com/clocks
Interface	interface.ti.com
Logic	logic.ti.com
Power Mgmt	power.ti.com
Microcontrollers	microcontroller.ti.com
RFID	www.ti-rfid.com
RF/IF and ZigBee® Solutions	www.ti.com/lprf

Applications

Audio	www.ti.com/audio
Automotive	www.ti.com/automotive
Broadband	www.ti.com/broadband
Digital Control	www.ti.com/digitalcontrol
Medical	www.ti.com/medical
Military	www.ti.com/military
Optical Networking	www.ti.com/opticalnetwork
Security	www.ti.com/security
Telephony	www.ti.com/telephony
Video & Imaging	www.ti.com/video
Wireless	www.ti.com/wireless

Mailing Address: Texas Instruments, Post Office Box 655303, Dallas, Texas 75265
Copyright © 2008, Texas Instruments Incorporated